





Hydraulic hammers



HP Series



A TOOL FOR EVERY JOB

Application areas

		L	M	S	
 Mining and Quarry	Preliminary works	• Overburden removal	○	○	
		• Bench, road & ramp leveling	○	○	
		• Roof, face & rib scaling	○	○	
	Secondary demolition	• Boulder reduction in rock pile	○	○	
		• Removing blockages at crushing systems	○	○	○
	Primary rock breaking	• Selective rock breaking	○	○	
• Blastfree mining		○			
Demolition & renovation 	Light Demolition	• Demolition of masonry structures	○	○	○
		• Brickwork		○	○
		• Natural stone		○	○
		• Renovation of interiors			○
		• Autoclaved aerated concrete	○	○	○
Demolition of non-reinforced concrete structures	• Primary demolition of lightweight and standard concrete	○	○	○	
	• Primary demolition of heavyweight concrete	○	○	○	
	• Wall Elements	○	○	○	
	• Secondary demolition	○	○	○	
Composite steel & concrete structure demolition	• Primary demolition of lightweight and standard reinforced concrete	○	○		
	• Primary demolition of heavyweight steel - reinforced concrete	○	○		
	• Secondary Demolition floors, slabs and beams	○	○	○	
	• Separating rebars from pillars and struts				
	• Fiber-reinforced concrete	○	○	○	
	• Cutting rebars and steel reinforcements				
Demolition of metallic buildings and structures	• Demolition of refineries				
	• Cutting of Metal and steel structures				
	• Cutting steel girders/beams				
	• Cutting reinforcements				
Sorting and Loading	• Sorting				
	• Loading				
	• Waste handling				
	• Site clean-up				
Pavement demolition	• Asphalt	○	○	○	
	• Concrete	○	○	○	
	• Composite surfaces	○	○	○	
Earth Moving and Construction 	Earth moving works	• Trenching	○	○	○
		• Ground excavation	○	○	○
		• Floor leveling			
		• Soil compaction			
		• Trench compaction			
		• Loading soil or bulk material			
Foundation works	• Building foundation excavation	○	○		
	• Ground leveling	○	○	○	
Building construction	• Foundation pile driving		○	○	
	• Compaction around pillars				

		L	M	S	
Infrastructures 	Tunnelling	• Tunnel excavation	○	○	○
		• Roof, face & rib scaling	○	○	○
	Underwater application	• Dredging	○	○	○
		• Dock deepening & extension	○	○	○
		• Canal deepening & extension	○	○	○
		• Loading soil or bulk material			
Trenching	• Handling rock or breakwaters				
	• Oil & gas, water & sewage (deep trenching)	○	○	○	
	• Trenching		○	○	
Road construction	• Trench soil compaction		○	○	
	• Pile driving and guard rail driving		○	○	
	• Asphalt repair				
	• Maintenance work (driveways, sidewalks and parking lots)				
Slag recycling	• Block paving				
	• Boulder reduction in slag heaps	○	○		
Cleaning & debricking	• Removing blockages at crushing systems	○	○	○	
	• Ladles	○	○	○	
	• Converter mouths	○	○	○	
Agriculture and Forestry 	Gardening & Landscaping	• Kilns	○	○	○
		• Fencing	○	○	○
		• Ground excavation	○	○	○
		• Rock breaking	○	○	○
		• Pit planting	○	○	○
		• Stump splitting	○	○	○
		• Golf course maintenance			
		• Root and stump grinding			
		• Hedgerow clearance and rejuvenation			
		• Grinding of logging residues			
Forestry	• Timber log handling				
	• Maintenance of green area, small trees and brush				
	• Creation and upkeep of woodland corridors and firebreaks				
	• Tree clearing				
	• Vegetation clearing				
	• Branch clearing				

L | Large hammers

M | Medium hammers

S | Small hammers

Hydraulic hammers

Indeco HP

Indeco HP hydraulic hammers are an outstanding expression of Italian high-tech and construction quality applied to demolition. In-depth research into hydraulic systems, materials, heat treatment and accessories have enabled Indeco to establish a reputation on markets throughout the world for product excellence.

With its many different models, divided into large, medium and small and available in various versions, Indeco has the widest range of hammers available anywhere in the world. This provides end-users with a huge choice, ensuring that they can find the ideal hammer/excavator match.

Small hammers

Despite their compact size, Indeco's range of small hammers are exceptionally reliable, quiet and efficient, and best suited for such jobs as excavations work, highway maintenance, demolitions and recycling in city areas and building refurbishment. Their versatility makes them extremely efficient in specialist jobs such as maintenance in iron foundries.

Medium hammers

Their excellent weight/power ratio and their slimline structure make the mid-range Indeco hammers the ideal choice for classical applications, such as demolishing buildings, earthworks in inhabited areas and secondary demolitions in quarries, as well as for more specific tasks. In fact, mid-range hammers are used for underwater work (using a special kit) as well as for digging narrow deep trenches and removing casting slag from blast furnaces.

Large hammers

Combining maximum power with the effectiveness of intelligent technology, Indeco's larger hammers are unbeatable when it comes to completing the toughest jobs in the shortest possible time-frame – whether it's the biggest demolition jobs, primary breaking in quarries, digging foundations, or excavating huge rail and road tunnels.



Features of Indeco hammers

All Indeco hammers have a special intelligent hydraulic system **[1]**, enabling them to automatically vary the energy and frequency of the blows according to the hardness of the material being demolished.

This optimises the hydraulic pressure delivered by the machine, thus improving productivity and enhancing the overall performance.

Exclusive features such as the synchronised internal distributor **[2]** aligned with the piston, the oil cushions **[3]** for vibration dampening and the short hydraulic flow pattern **[4]** make it possible to completely do away with seals in the distribution area, a decisive factor in extending the working life of the hammer and significantly reducing downtimes.

The use of special low-alloy steels, exclusively manufactured according to Indeco's own formula greatly lengthen the average working life of the major hammer components.

The housing **[5]** is made out of extra-strength HARDOX® steel wear plates, which eliminate buckling.

The piston **[6]** is divided into two parts, for greater impact energy and lower operating costs.

The centralised greasing system **[7]** enables the sliding parts to remain lubricated even when the hammer is operating horizontally, thus considerably reducing wear and tear on components and extending product lifetime.

The “quick change” interchangeable bushing **[8]** is available in various materials for different jobs; it is inserted into the lower tool bushing where the tool moves, and reduces maintenance times and costs, by cutting out the long machine downtimes needed to replace the traditional fixed bushing.

All carriers which mount Indeco hammers benefit from the Indeco dual shock-absorption system **[9]**: an internal hydraulic one and a mechanical one, located outside the body, which substantially reduce the vibrations transmitted to the excavator. The excavator boom is also subject to lower stress levels, as Indeco hammers are considerably lighter under

working conditions than rival makes in the same class. Alongside the standard versions there is also a super-soundproofed Whisper version, whose body is lined internally with sound-absorbent material **[10]** and an “anti-rumble” paint, which – combined with a few modifications to the bushing – enable noise emission levels to be considerably reduced. By lowering pressure peaks, the rechargeable hydraulic/nitrogen accumulator **[11]** also reduces stress in the excavator hydraulic circuit, keeps the gas charge and energy per blow constant, and reduces maintenance and operating costs.

ABF The ABF (Anti Blank Firing) system **[12]**, installed as standard on all of the medium- and large-range Indeco hammers, cuts out blank fire by eliminating any down pressure from the hammer whenever the tool is not resting firmly on the surface to be demolished. This increases the service life of all components subject to wear and tear, as well as reducing stress to the hammer body and excavator arm.

fs FUEL SAVING As well as being efficient and reliable, Indeco hydraulic hammers are now proving to be even more environmentally-friendly and low on fuel consumption. With a now even more efficient hydraulic system **[13]**, the HP series has now also become FS (Fuel Saving). Compared to other manufacturers’ models of equivalent weight and performance, Indeco hammers require less oil per minute and lower operating pressure. And as using lower hydraulic power means reducing the number of revolutions per minute on the carrier, they lead to fuel savings of up to 20%, while ensuring optimum performance and maximum productivity. This becomes even more evident when comparing the Indeco hammer with gas or gas/oil powered products of similar size manufactured by competitors.

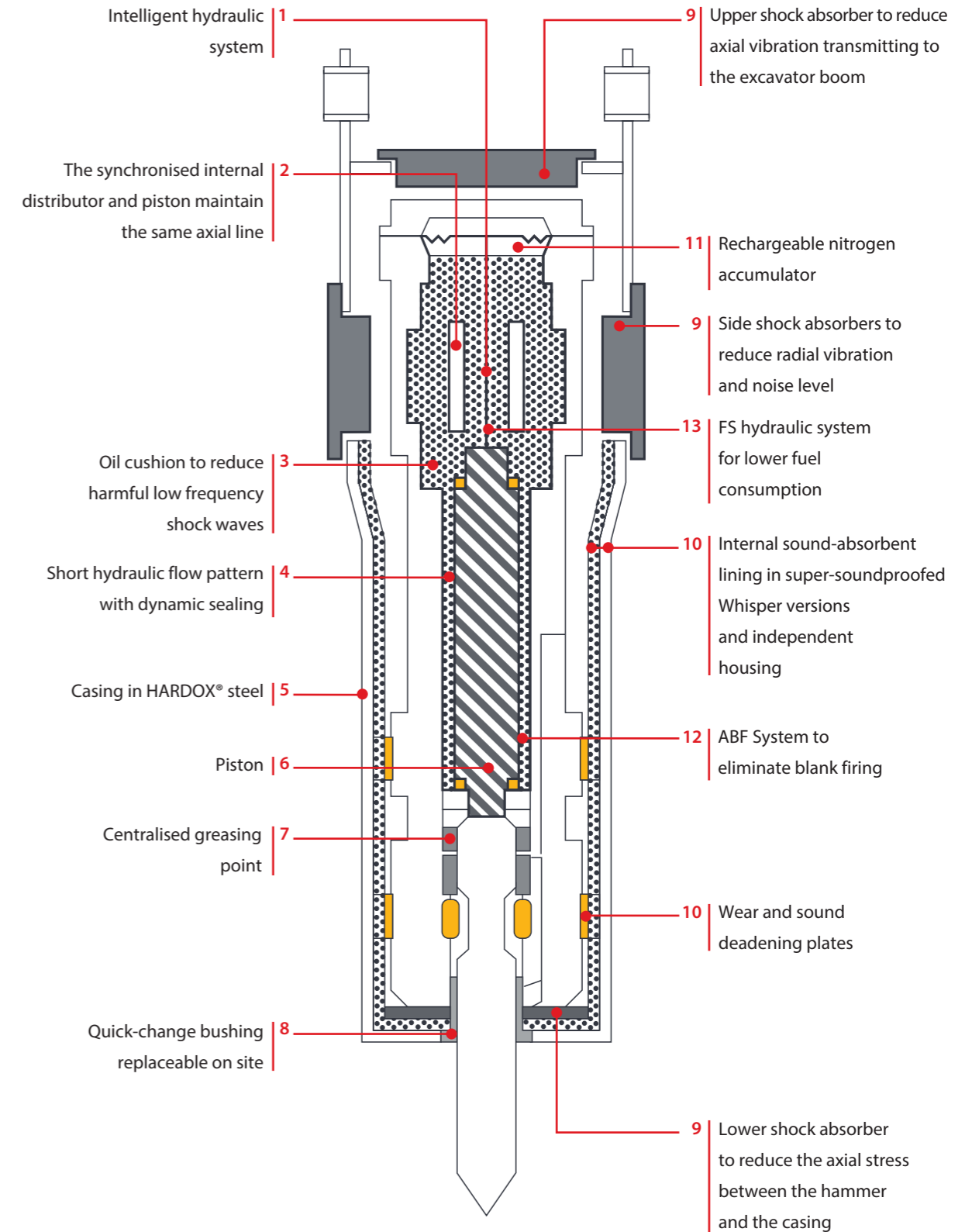

Small hammer range

HP series

These excellent jobsite companions are the most numerous class of models in the Indeco range.



Technical Data	HP 100 FS	HP 150 FS / HP 150 FS Heavy Duty	HP 200 FS	HP 400 FS
Type of carrier	1 2	1 2	1 2	1 2 3
Excavator weight (possible)	0,5 ÷ 2 tons	0,7 ÷ 3 tons	1,4 ÷ 5 tons	1,7 ÷ 6,5 tons
Weight of hammer when operated	59 Kg	80 / 98 Kg (Heavy Duty)	160 Kg	230 Kg
Steel diameter	42 mm	45 mm	48 mm	65 mm
Pressure adjusted to the excavator	160 bars	160 bars	160 bars	160 bars
Back pressure max	16 bars	11 bars	11 bars	12 bars
Energy class per blow	160 joule	230 joule	300 joule	550 joule
Number of blows per minute	400 ÷ 1900 n/min	540 ÷ 2040 n/min	700 ÷ 1800 n/min	540 ÷ 1670 n/min

Carrier key



HP 550 FS	HP 600 FS	HP 700 FS	HP 900 FS
1 2 3	1 2 3	1 3	1 3
3 ÷ 9 tons	3,5 ÷ 10,5 tons	4 ÷ 12 tons	5 ÷ 14 tons
320 Kg	390 Kg	440 Kg	550 Kg
75 mm	75 mm	80 mm	90 mm
160 bars	170 bars	170 bars	170 bars
12 bars	11 bars	12 bars	11 bars
750 joule	850 joule	950 joule	1200 joule
780 ÷ 1720 n/min	600 ÷ 1340 n/min	620 ÷ 1500 n/min	570 ÷ 1180 n/min

For data on the pressure adjusted to the hammer and on oil flow, please consult the "Parameters for selecting and adjusting the hammer" page.

N.B. All illustrations and numerical data in this catalog are purely indicative and subject to change at our discretion and without notice. We therefore reserve the right to modify them with a view to improving and continuously developing our product.

Medium hammer range

HP series

A perfect blend of power and agility characterises the mid range Indeco hammers, tireless partners even on the toughest of jobs.



Technical Data	HP 1200 FS	HP 1500 FS	HP 1800 FS
Type of carrier	1 3 4	4 5	4 5
Excavator weight (possible)	6,5 ÷ 16 tons	10 ÷ 20 tons	12 ÷ 22 tons
Weight of hammer when operated	650 Kg	850 Kg	1000 Kg
Steel diameter	90 mm	110 mm	115 mm
Pressure adjusted to the excavator	170 bars	180 bars	180 bars
Back pressure max	8,5 bars	10 bars	8 bars
Energy class per blow	1500 joule	1750 joule	2000 joule
Number of blows per minute	450 ÷ 980 n/min	420 ÷ 1000 n/min	440 ÷ 1060 n/min

HP 2000 FS	HP 2500 FS	HP 2750 FS	HP 3000 FS
4 5	4 5	5	5
15 ÷ 25 tons	16 ÷ 28 tons	16 ÷ 30 tons	19 ÷ 32 tons
1200 Kg	1500 Kg	1690 Kg	1900 Kg
120 mm	130 mm	135 mm	140 mm
180 bars	180 bars	190 bars	200 bars
8 bars	7 bars	7 bars	8 bars
2500 joule	3400 joule	3700 joule	4400 joule
460 ÷ 940 n/min	400 ÷ 870 n/min	400 ÷ 870 n/min	360 ÷ 870 n/min

Carrier key



For data on the pressure adjusted to the hammer and on oil flow, please consult the "Parameters for selecting and adjusting the hammer" page.

N.B. All illustrations and numerical data in this catalog are purely indicative and subject to change at our discretion and without notice. We therefore reserve the right to modify them with a view to improving and continuously developing our product.

Large hammer range HP series

This is the most prestigious class, containing the top range of Indeco hammers. They are top hammers not only in terms of size, but also in their outstanding performance.



Technical Data	HP 3500 FS	HP 4000 FS	HP 5000 FS	HP 6000 FS
Type of carrier	5	5	5	5
Excavator weight (possible)	21 ÷ 38 tons	23 ÷ 42 tons	27 ÷ 50 tons	30 ÷ 55 tons
Weight of hammer when operated	2200 Kg	2500 Kg	3150 Kg	3600 Kg
Steel diameter	145 mm	150 mm	160 mm	170 mm
Pressure adjusted to the excavator	210 bars	210 bars	210 bars	210 bars
Back pressure max	7 bars	8 bars	7 bars	7 bars
Energy class per blow	5200 joule	6200 joule	8000 joule	9000 joule
Number of blows per minute	370 ÷ 760 n/min	340 ÷ 820 n/min	300 ÷ 670 n/min	300 ÷ 650 n/min

HP 7000 FS	HP 9000 FS	HP 12000 FS	HP 18000 FS Plus
5	5	5	5
32 ÷ 63 tons	39 ÷ 80 tons	45 ÷ 120 tons	60 ÷ 140 tons
4000 Kg	5000 Kg	7800 Kg	11050 Kg
180 mm	195 mm	215 mm	250 mm
210 bars	210 bars	230 bars	230 bars
8,5 bars	8 bars	9 bars	11 bars
10500 joule	15000 joule	20000 joule	25000 joule
320 ÷ 580 n/min	270 ÷ 540 n/min	240 ÷ 550 n/min	240 ÷ 460 n/min

Carrier key



Compact excavator

Miniloader

Backhoe loader

Wheeled excavator

Tracked excavator

For data on the pressure adjusted to the hammer and on oil flow, please consult the "Parameters for selecting and adjusting the hammer" page.

N.B. All illustrations and numerical data in this catalog are purely indicative and subject to change at our discretion and without notice. We therefore reserve the right to modify them with a view to improving and continuously developing our product.

Productivity

Parameters for selecting and adjusting the hammer

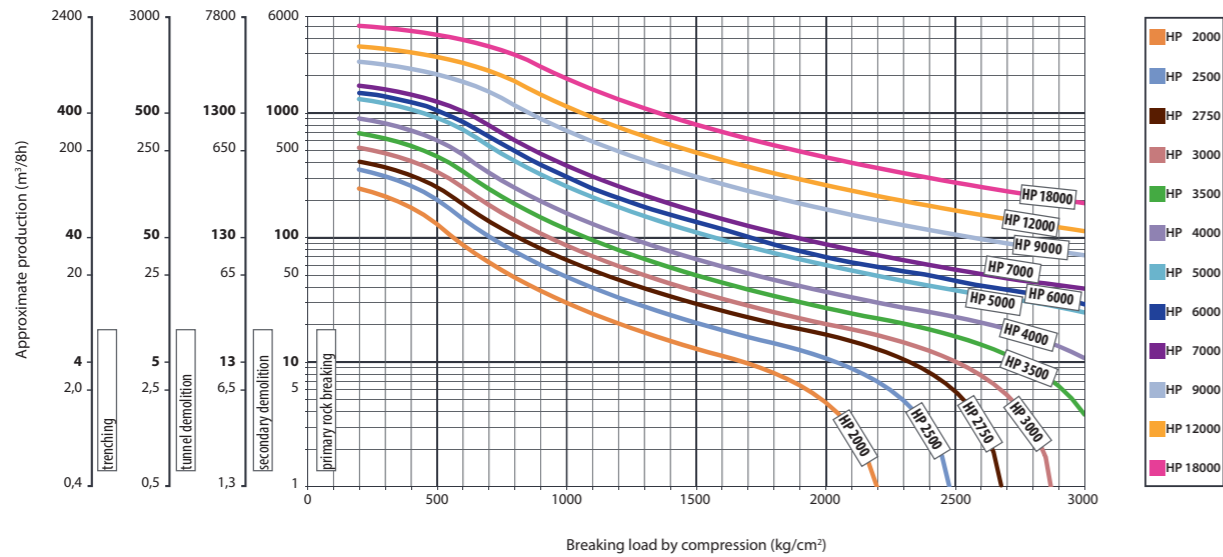
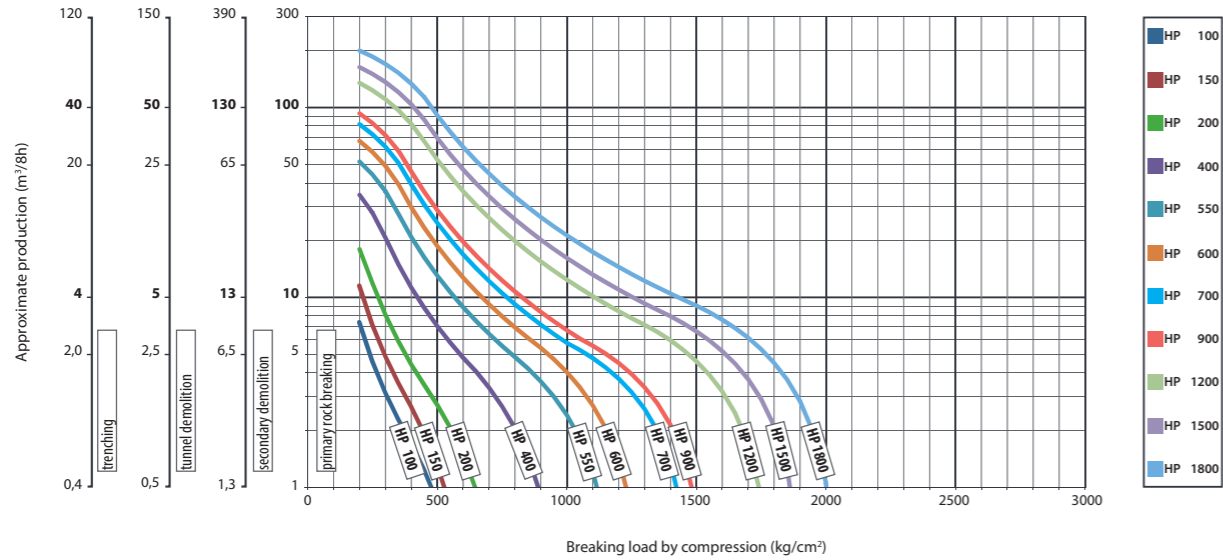

N.B. These nominal values are for reference purposes and are not binding

Noise levels

Noise levels measured* at various distances

Distance	10 m	15 m	20 m	25 m	30 m
HP model	96	92,5	90	88,1	86,5
HP Whisper model	93	89,5	87	85,1	83,5

Guaranteed noise level* corresponding to EU Directive 2006/42/EC

HP model	126
HP Whisper model	123

*values expressed in dB (A)

Model	Compatibility hammer/carrier (tons)*	Oil pressure adjustment (bars)/ oil flow (l/min)**	Model	Compatibility hammer/carrier (tons)*	Oil pressure adjustment (bars)/ oil flow (l/min)**
HP 100	0,5 2	105 115 120 125	HP 2500	16 28	115 125 130 140
HP 150	0,7 1,8	28 20 15 10	HP 2750	16 30	120 130 135 145
HP 200	0,8 2,5	40 30 20 15	HP 3000	19 32	125 135 140 150
HP 400	1,4 5	45 35 25 25	HP 3500	21 38	130 135 140 160
HP 550	1,7 6,5	65 45 35 30	HP 4000	23 42	130 140 145 160
HP 600	3 9	85 70 60 50	HP 5000	26 33	230 215 205 180
HP 700	3,5 7,5	105 115 120 125	HP 6000	27 50	130 140 145 160
HP 900	3,5 10,5	80 70 60 50	HP 7000	30 40	265 230 220 190
HP 1200	4 8,5	105 120 125 130	HP 9000	30 55	130 140 145 160
HP 1500	4 12	90 80 70 60	HP 12000	32 63	140 145 150 165
HP 1800	5 14	100 90 80 70	HP 18000	36 52	305 285 275 250
HP 2000	5,5 10	105 120 125 130		39 80	140 150 155 165
	6 12	105 95 85 70		46 68	355 325 315 290
	6,5 16	115 120 125 140		45 120	140 160 165 180
	8 13	125 110 100 80		58 90	420 380 370 325
	10 20	115 120 125 140		60 140	140 160 170 180
	12 17	130 120 110 85		75 120	520 470 460 420
	12 22	115 125 130 140			
	15 25	150 135 125 110			

*Suggested uses on machines with an overall weight (in tons):

Best Possible (match subject to approval by the Indeco dealer)

**Pressure adjusted to the hammer (bars) relative to oil flow (l/min):

Optimum pressure adjusted to the hammer (in bars) Optimal oil supply (l/min) Possible pressure/oil

Accessories

IDA (Indeco Dust Abatement) System

An innovative system that is particularly effective for reducing wear and tear on components, extending the working life of the hammer and protecting operators against exposure to microparticles of crystalline silica. It consists of a jet of high-pressure water spray, emitted by a number of nozzles **|1|** on the casing, which prevents dust from harming both the tool and the operator.

Recently updated to comply with the latest OSHA directives, the system is available in two different versions:

- **High-pressure system**

Available for medium-large to large hammers, it is made up of an air compressor and a high-pressure water pump, mounted onto the excavator and driven by two hydraulic motors powered by the excavator. A set of electrohydraulic valves enable the excavator operator to activate the pump and compressor independently, thus starting up either one or both of the protection devices: the dust-abatement kit, which uses a fine water spray and the dust shield, which uses the internal pressurization of the hammer **|2|** to prevent dust, water and debris from getting into the hammer through the bushing, as can occur during tunnel demolitions and underwater excavations.

- **Low-pressure system**

Designed for smaller hammers and pulverizers, the technology involves inserting a vaporizing plate with four nozzles **|3|**, where the mounting bracket is attached, which enables it to cover the whole working area (whatever position it is in) and reduce the amount of dust produced, even on windy days.

The new system only needs a low-pressure water supply and the sprayers turn on automatically only when the attachment is in action, thus also reducing water consumption.

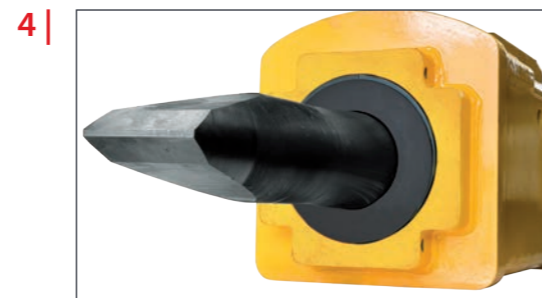
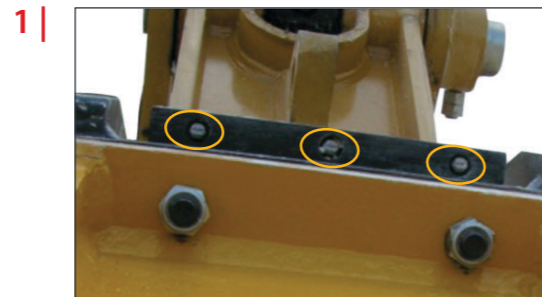

|6|

|7|

|8|

|9|

Anti-Grease and Anti-Dust System

This system, which is crucial when working in dusty environments and when tunnelling, is made up of two collars. Both are adherent to the tool **|4|**, and which prevent dust from getting in and grease from getting out, improving lubrication levels and thus lengthening the working life of the main hammer components.

Indeco Lube automatic greasing systems

Among the most important accessories on hydraulic hammers, automatic greasing systems developed exclusively for Indeco by Bekalube technical staff are designed to keep hammers in perfect working order, by using just the right amount of lubricant and cutting out the down times needed for the operator to carry out manual greasing.

There are two types of greasing unit – either an on-board system that can be fitted directly onto the hammer and which uses a cartridge pump, or else an excavator-mounted unit with its own grease tank **|5|**.

In both cases, these systems are connected to the hammer through a single centralized greasing point **|6|**, which enables the lubricant to reach all of the bushings and the moving parts at the tool, inside the hammers and on the retaining axle.

On-Board greasing systems

- **“Small”** Single-shot cartridge pump with only one hydraulic line **|7|**, which accepts a single 250 or 400 g cartridge – for hammers from the HP 550 to the HP 1800
- **“Compact”** Pump with two hydraulic lines, which accepts a single 400 g cartridge **|8|** – for hammers from the HP 2000 to the HP 7000
- **“Maxi”** cPump with two hydraulic lines, which accepts a dual 400 g + 400 g cartridge **|9|** – for hammers from the HP 9000 to the HP 18000

Carrier-mounted systems

- Five-litre hydraulically or electrically-operated tank
- 18/20 kg hydraulically or electrically-operated drum immersion pump

The tools

Special Indeco Sirio lubricant

It is vital that a specific lubricant be used, to ensure the durability of the main components of the hammer. Indeco's **|10|** Sirio HBS grease, with solid additives is particularly resistant to oxidation, can withstand extreme pressures and temperatures and shows excellent adhesion and water-resistance.



Pins and bushings

|11| Designed to make it easier to mount all Indeco products onto the excavator boom, with or without a mounting bracket.



Mounting brackets

Each Indeco mounting bracket model **|12|** can be used with all Indeco products in the same class.



Folding mounting bracket

A special mounting bracket **|13|** for folding the hammer away directly under the carrier boom.



Connecting hoses

We recommend using original Indeco high- and low-pressure hoses **|14|** to connect various tools to the hydraulic system on the carrier.



Chisel tool

Suitable for all earthworking or narrow-section excavation jobs on medium to hard stratified rock.



Moil point tool

Suitable for breaking up concrete, or medium-hard non-stratified rock. Secondary demolition: average, hard or extremely hard blocks.



Asphalt cutter / shovel tool

For cutting or breaking the road surface, breaking floors, walls, brick or tuff walls. Available in the in-line (asphalt cutter) and 90° transversal (shovel) versions according to the working direction.

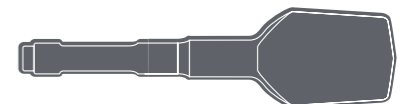
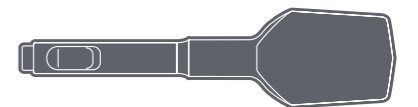

Pile driver

Suitable for pilework or press-moulded supports for guardrails, etc.



Pyramidal point

Suitable for demolishing hard reinforced concrete flooring, as well as sedimentary material.



Cobra chisel tool

Suitable for all types of excavation work on medium-hard to hard rock, non-stratified rock or rock which tends to pulverise when being broken up, puddingstones.



Blunt tool

Suitable for breaking up blocks of any hardness, or to reduce the size of rubble.



The full range of Indeco hammers

Hammer	Weight	Hammer	Weight
HP 100	59 Kg	HP 2000	1200 Kg
HP 150	80 Kg	HP 2500	1500 Kg
HP 150 Heavy Duty	98 Kg	HP 2750	1690 Kg
HP 200	160 Kg	HP 3000	1900 Kg
HP 400	230 Kg	HP 3500	2200 Kg
HP 550	320 Kg	HP 4000	2500 Kg
HP 600	390 Kg	HP 5000	3150 Kg
HP 700	440 Kg	HP 6000	3600 Kg
HP 900	550 Kg	HP 7000	4000 Kg
HP 1200	650 Kg	HP 9000	5000 Kg
HP 1500	850 Kg	HP 12000	7800 Kg
HP 1800	1000 Kg	HP 18000 Plus	11050 Kg

Indeco ind S.p.a.
 viale Lindemann, 10 z.i. - 70132 Bari - Italy
 tel. +39 080 531 33 70 - fax +39 080 537 79 76
 info@indec.it - www.indec.it/en

