

LOADER

SKL



SKL 304

SKL 308

	HP	30 - 70	60 - 100
	cat.	I - II	II - III
	mm	1400	1750

Suitable for:



SKT

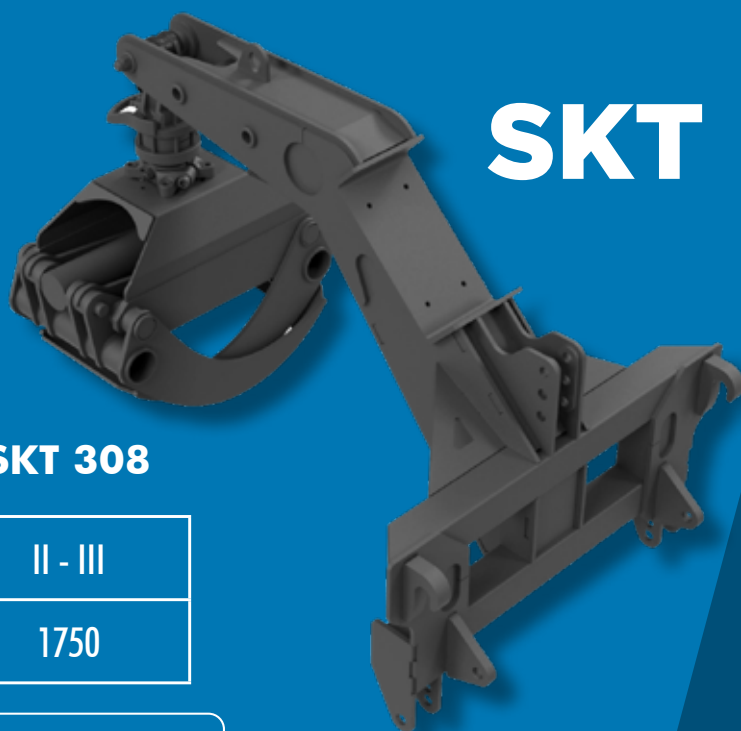

SKT 304

SKT 308

	cat.	I - II	II - III
	mm	1400	1750

Suitable for:



MULTI-FUNCTIONAL LOG SPLITTER

GO-CUT



Suitable for:





FIREWOOD GRAPPLES

POLY

150

300

400

	Ton	2,5 - 7,0	5,0 - 8,0	5,0 - 8,0
	mm	1411	1750	1880
	n.	5	5	5
	Kg	140	260	335







Suitable for:



AGRO-FORESTAL FORK







		FLT				
		8	10	12	14	16
	Ton	2,5 - 8,0	3,5 - 8,0	3,5 - 8,0	4,0 - 8,0	4,0 - 8,0
	mm	1340	1340	1340	1340	1340
	n.	4+4	5+5	6+6	7+7	8+8
	mm	550	700	850	1000	1150

Suitable for:



CLAMSHELL BUCKETS



		BK					
		300	400	500	600	700	800
	Ton	2,5 - 8,0	2,5 - 8,0	3,5 - 8,0	3,5 - 8,0	4,0 - 8,0	4,0 - 8,0
	mm	1240	1240	1240	1240	1240	1240
	lt.	100	125	150	175	200	225
	kg.	150	160	170	180	200	220

Suitable for:

