



CATALOGUE



www.m3srl.com

02
rev.0





WE USE ONLY
**Green
Energy**

| MIXER BUCKET WITH CENTRAL DISCHARGE | p.8 | ✓ | ✓ | ✓ | ✓ | ✓ | ✓ |
|-------------------------------------|------|---|---|---|---|---|---|
| MIXER BUCKET WITH SIDE DISCHARGE | p.10 | ✓ | ✓ | ✓ | ✓ | ✓ | ✓ |
| TWIN DOOR MIXER BUCKET | p.12 | ✓ | ✓ | ✓ | ✓ | ✓ | ✓ |
| SWEEPER BUCKET HD | p.16 | - | ✓ | ✓ | ✓ | - | ✓ |
| SWEEPER BUCKET D | p.18 | - | ✓ | ✓ | ✓ | ✓ | ✓ |
| SWEEPER BUCKET DS | p.20 | - | ✓ | ✓ | ✓ | - | - |
| SWEEPER BUCKET C | p.22 | - | ✓ | ✓ | - | - | - |
| BROOM SWEEPER | p.24 | - | - | ✓ | - | ✓ | - |
| ANGLED BROOM SWEEPER | p.26 | - | - | ✓ | - | - | ✓ |
| EXCAVATOR SWEEPER | p.28 | ✓ | - | - | - | - | - |
| QUICK-HITCH | p.30 | - | ✓ | - | ✓ | - | - |
| ISO 24410 ADAPTOR | p.31 | ✓ | ✓ | ✓ | ✓ | - | - |
| FORK CARRIAGE | p.32 | ✓ | ✓ | ✓ | ✓ | - | ✓ |
| GRADER BLADE | p.36 | - | - | - | - | - | ✓ |
| DUAL GRADER BLADE | p.38 | - | - | - | - | - | ✓ |
| DOZER BLADE | p.42 | - | ✓ | - | - | - | ✓ |

| TILT DOZER BLADE | p.44 | - | ✓ | - | - | - | ✓ |
|--|------|---|---|---|---|---|---|
| LEVELING BOX DOZER BLADE | p.46 | - | - | - | - | - | ✓ |
| SNOW PLOW | p.48 | - | ✓ | ✓ | - | - | ✓ |
| SNOW BLOWER | p.50 | - | - | - | ✓ | - | ✓ |
| HYDRAULIC BUSH CUTTER | p.52 | - | - | - | - | - | ✓ |
| HYDRAULIC BUSH CUTTER MH5 | p.54 | - | ✓ | - | ✓ | - | ✓ |
| HYDRAULIC MULCHING HEAD HD | p.56 | ✓ | - | - | ✓ | - | - |
| HYDRAULIC MULCHING HEAD STD | p.58 | ✓ | - | - | ✓ | - | - |
| TRIMMER MC SERIES | p.62 | ✓ | - | - | ✓ | - | - |
| INDUSTRIAL BUCKET WITH GRAPPLE | p.64 | - | - | - | - | - | ✓ |
| STANDARD BUCKET | p.65 | - | - | - | - | - | ✓ |
| AUGERS DRIVES: MINI EXCAVATORS FROM 0,75T TO 5T - SKID STEER LOADER STD | p.68 | ✓ | - | ✓ | - | - | ✓ |
| AUGERS DRIVES: EXCAVATORS FROM 4T TO 10T - SKID STEER LOADER STD/HF | p.70 | ✓ | - | ✓ | ✓ | - | ✓ |
| AUGER DRIVES: 10T - 20T EXCAVATORS | p.72 | ✓ | - | ✓ | ✓ | - | - |
| FRONT SCREENING BUCKET | p.76 | - | - | - | - | - | ✓ |

MIXING

- Bottom and helix made of wear resistant STEEL HB400
- Rounded fixed safety grill complete with bag breaker
- Electric valve, hydraulic hoses + electric connection kit
- Attachment to the machine



MIXER BUCKET WITH CENTRAL DISCHARGE

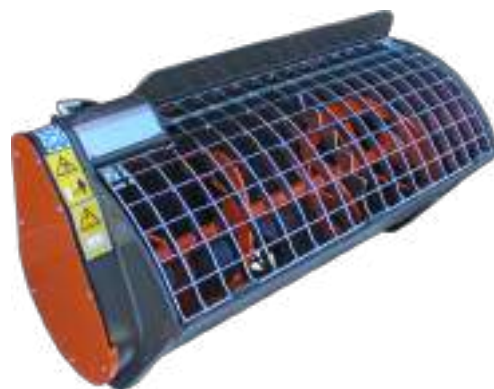

- Welded helix made of wear steel HB400
- Unloading pipe 1500mm length
- Sintered steel seal group

Suitable for any type of earth moving machine:

| | | |
|---------------------------------------|-------|--|
| Skid loader | _____ | 150/200/250/350/450 |
| Backhoe loaders-Compact wheel loaders | _____ | BM450/600/700 |
| Wheel loaders | _____ | BM1100/1500/2000 |
| Telehandlers | _____ | 2,0/2,5 t BM350/450 3,0/3,5 t BM600 >4,5 t BM700 |
| Excavators | _____ | starting from 3,5 t |

MIXER BUCKET WITH SIDE DISCHARGE



- Bolted helix made of wear steel HB400
- Hydraulic motor fully protected
- Unloading pipe (length 1500mm)
- Bolted attachment as standard supply, starting from the class 3 models
- Polyurethane seal group

TWIN DOOR MIXER BUCKET



- Bolted helix made of wear steel HB400
- Hydraulic motor fully protected
- Unloading pipe (length 1500mm) and side chute
- Bolted attachment as standard supply, starting from the class 3 models
- Polyurethane seal group

| | |
|---|--|
| Suitable for any type of earth moving machine: | |
| Skid loader_____ | BM100/150/200/250/330/400SL |
| Backhoe loaders-Compact wheel loaders_____ | BM400/500/600SL |
| Wheel loaders_____ | BM700/1100SL |
| Telehandlers_____ | 2,0/2,5 t BM250/330/400SL 3,0/3,5 t BM500/600SL >4,5 t BM700SL |
| Excavators_____ | starting from 3,5 t |

| | |
|---|--|
| Suitable for any type of earth moving machine: | |
| Skid loader_____ | BM150/200/250/330/400TD |
| Backhoe loaders-Compact wheel loaders_____ | BM400/500/600TD |
| Wheel loaders_____ | BM700/1100TD |
| Telehandlers_____ | 2,0/2,5 t BM250/330/400TD 3,0/3,5 t BM500/600TD >4,5 t BM700TD |
| Excavators_____ | starting from 3,5 t |

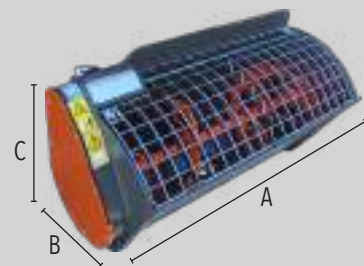

DIMENSIONS

| | | BM 150 | BM 200 | BM 250 | BM 350 | BM 450 | BM 600 | BM 700 | BM 1100 | BM 1500 | BM 2000 |
|---|---------------|--------|--------|--------|--------|--------|--------|--------|---------|---------|---------|
| A | Width | 1325 | 1325 | 1505 | 1520 | 1620 | 1900 | 1900 | 2165 | 2260 | 2760 |
| B | Depth | 800 | 800 | 830 | 900 | 900 | 1000 | 1100 | 1320 | 1450 | 1450 |
| C | Height | 600 | 670 | 690 | 815 | 815 | 910 | 1030 | 1160 | 1180 | 1180 |

The concrete mixer bucket M3 is equipped with: BOTTOM AND HELIX made of wear resistant STEEL HB400 - Rounded fixed safety grid complete with bag-breaker - Electric valve - Hydraulic hoses - Electric connection kit - Flat Face Couplings (only on SSL) - hydraulic opening of the bottom through a cylinder with covered rod - chain tensioner - unloading pipe length mm 1500 - attachment to the machine.

By coupling the mixing bucket to the compact loaders, please consider the following: the operating load of the machine \geq the full load weight of the mixer bucket. In case the longitudinal and the horizontal distance of the center of gravity of the mixing bucket is lower than the one of the standard bucket (according to the data supplied by the manufacturer of the mixing bucket) it is possible to add the weight of the standard bucket to the operating load.

OPTIONALS

| | | |
|--|--|---|
| | Hydraulic opening of the safety grill including the safety valve. Not available in BM 250 model | Opening of the safety grill through gas springs including the safety valve. |
| Multi-Hitch option | Electric winder | Radio control for bottom opening without electric line |
| Bolted plate for excavator-direct coupling | 8 / 14 pins connector | |





| MODEL | BM 150 | BM 200 | BM 250 | BM 350 | BM 450 | BM 600 | BM 700 | BM 1100 | BM 1500 | BM 2000 |
|------------------------------|-----------|-----------|---------|---------|---------|---------|---------|---------|-----------------|-----------------|
| Capacity [lt] | 150 | 200 | 250 | 350 | 450 | 600 | 700 | 1100 | 1500 | 2000 |
| Transmission | gear unit | gear unit | chain | chain | chain | chain | chain | chain | chain, 2 motors | chain, 2 motors |
| Empty weight [kg] | 260 | 270 | 380 | 395 | 420 | 630 | 710 | 1250 | 1700 | 2100 |
| Full load weight [kg] | 620 | 750 | 980 | 1235 | 1500 | 2070 | 2390 | 3890 | 5300 | 6900 |
| Min/max flow rate [lt/min] | 30/40 | 30/40 | 30/75 | 35/75 | 35/75 | 65/75 | 70/150 | 100/114 | 140/300 | 200/228 |
| Max pression cont/peak [bar] | 140/205 | 140/205 | 230/300 | 210/300 | 210/300 | 140/300 | 150/310 | 205/330 | 150/310 | 205/330 |

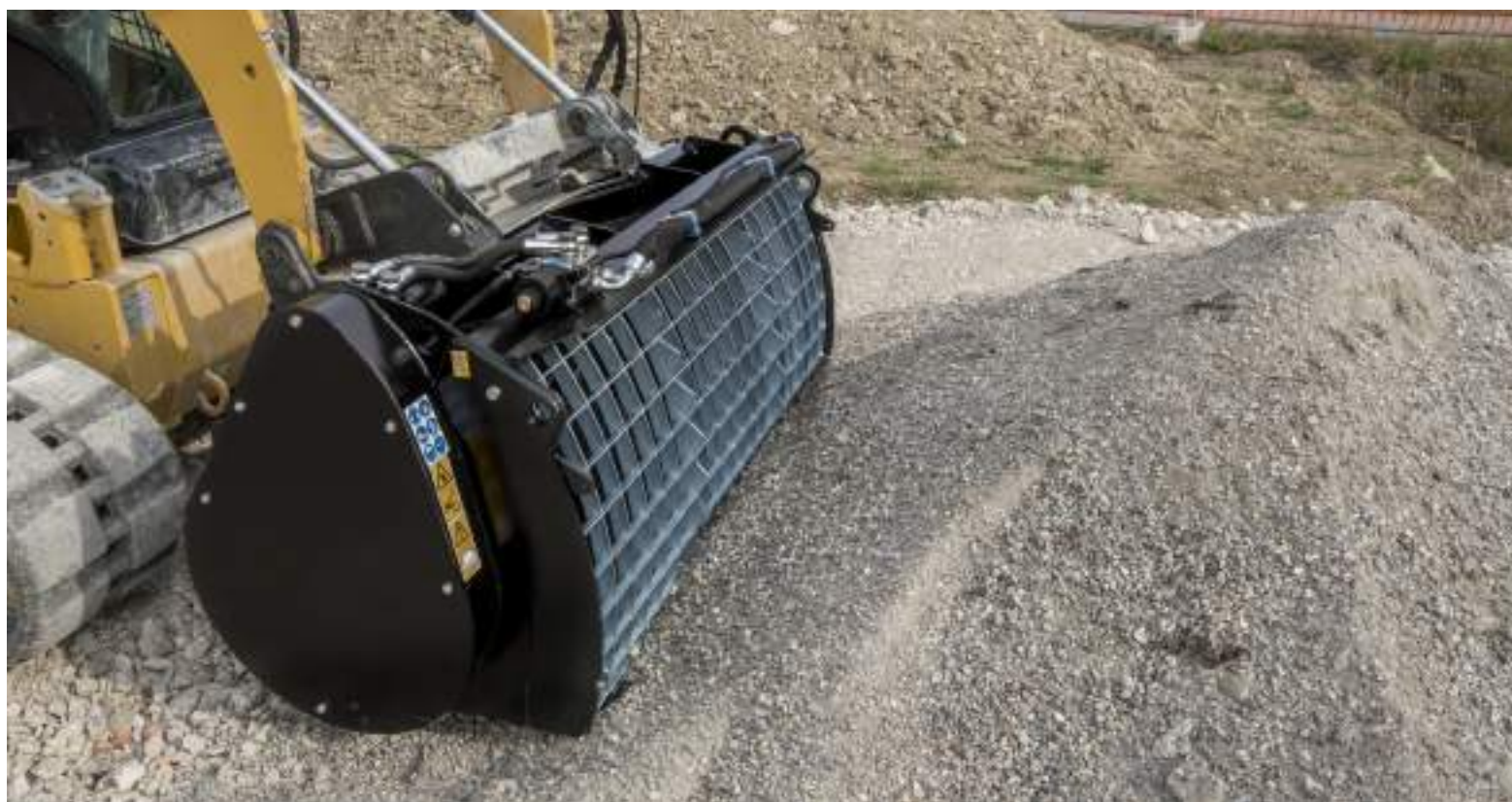

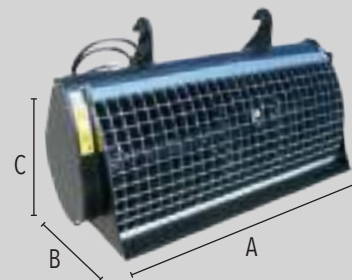

DIMENSIONS

| | | BM 100 SL* | BM 150 SL | BM 200 SL | BM 250 SL | BM 330 SL | BM 400 SL | BM 500 SL | BM 600 SL | BM 700 SL | BM 1100 SL |
|---|---------------|------------|-----------|-----------|-----------|-----------|-----------|-----------|-----------|-----------|------------|
| A | Width | 1180 | 1285 | 1490 | 1495 | 1605 | 1715 | 1795 | 1940 | 2090 | 2160 |
| B | Depth | 700 | 660 | 660 | 860 | 860 | 860 | 1075 | 1075 | 1075 | 1305 |
| C | Height | 560 | 645 | 645 | 800 | 800 | 800 | 1033 | 1033 | 1033 | 1250 |

The concrete mixer bucket M3 model SL is equipped with: safety rounded grill with bag splitter - BOTTOM and bolted HELIX made of wear steel HB400 - hydraulic motor fully protected - chain tensioner - electric valve with hydraulic hoses - electrical connection kit - hydraulic hoses - flat face couplings (only for SSL) - hydraulic opening of the bottom through a cylinder with covered rod - unloading pipe L=1500 mm.- attachment to the machine (bolted attachment as standard supply, starting from the model BM 500 SL).

By coupling the mixing bucket to the compact loaders, please consider the following: the operating load of the machine \geq the full load weight of the mixer bucket. In case the longitudinal and the horizontal distance of the center of gravity of the mixing bucket is lower than the one of the standard bucket (according to the data supplied by the manufacturer of the mixing bucket) it is possible to add the weight of the standard bucket to the operating load.

OPTIONALS

| | | |
|--|---|---|
| | Hydraulic opening of the safety grill including the safety valve. | Opening of the safety grill through gas springs including the safety valve. |
| Multi-Hitch option | Electric winder | Radio control for bottom opening without electric line |
| Bolted plate for excavator-direct coupling | 8 / 14 pins connector | Side chute |



| MODEL | BM 100 SL* | BM 150 SL | BM 200 SL | BM 250 SL | BM 330 SL | BM 400 SL | BM 500 SL | BM 600 SL | BM 700 SL | BM 1100 SL |
|------------------------------|------------|-----------|-----------|-----------|-----------|-----------|-----------|-----------|-----------|------------|
| Class | - | 1 | 1 | 2 | 2 | 2 | 3 | 3 | 3 | 4 |
| Capacity [lt] | 100 | 150 | 200 | 250 | 330 | 400 | 500 | 600 | 700 | 1100 |
| Transmission | gear unit | chain | chain | chain | chain | chain | chain | chain | chain | chain |
| Empty weight [kg] | 205 | 290 | 315 | 415 | 435 | 460 | 695 | 715 | 765 | 1030 |
| Full load weight [kg] | 445 | 650 | 795 | 1015 | 1227 | 1418 | 1895 | 2155 | 2445 | 3670 |
| Min/max flow rate [lt/min] | 25/70 | 30/60 | 30/60 | 40/75 | 35/75 | 35/75 | 70/150 | 70/150 | 70/150 | 100/115 |
| Max pression cont/peak [bar] | 140/225 | 175/225 | 175/225 | 175/225 | 210/300 | 210/300 | 150/310 | 150/310 | 150/310 | 205/330 |

* this mixer bucket is only available with the side discharge, without unloading pipe and electric valve.



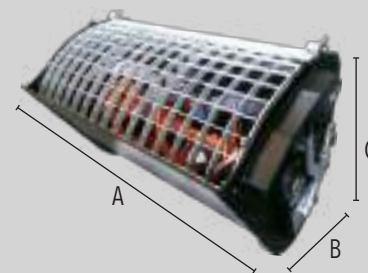

DIMENSIONS

| | | BM 150 TD | BM 200 TD | BM 250 TD | BM 330 TD | BM 400 TD | BM 500 TD | BM 600 TD | BM 700 TD | BM 1100 TD |
|---|---------------|-----------|-----------|-----------|-----------|-----------|-----------|-----------|-----------|------------|
| A | Width | 1350 | 1560 | 1560 | 1670 | 1780 | 1865 | 2010 | 2160 | 2280 |
| B | Depth | 660 | 660 | 860 | 860 | 860 | 1075 | 1075 | 1075 | 1305 |
| C | Height | 645 | 645 | 800 | 800 | 800 | 1033 | 1033 | 1033 | 1250 |

The concrete mixer bucket M3 model TD is equipped with: safety grill with bag splitter - BOTTOM and bolted HELIX made of wear resistant steel HB400 - hydraulic motor fully protected - chain tensioner - electric valve with hydraulic hoses - electric connection kit M3 - supply hoses - flat face couplings (only for SSL) - hydraulic opening of the bottom through a cylinder with covered rod - manually-operated side discharge - unloading pipe L=1500 mm - side chute extension - attachment to the machine (bolted attachment as standard supply starting from mod. BM500TD).

By coupling the mixing bucket to the compact loaders, please consider the following: the operating load of the machine \geq the full load weight of the mixer bucket. In case the longitudinal and the horizontal distance of the center of gravity of the mixing bucket is lower than the one of the standard bucket (according to the data supplied by the manufacturer of the mixing bucket) it is possible to add the weight of the standard bucket to the operating load.

OPTIONALS

| | | |
|--------------------|---|--|
| | Opening of the safety grill through gas springs including the safety valve. | Radio control for bottom opening without electric line |
| Multi-Hitch option | Electric winder | Bolted plate for excavator-direct coupling |





| MODEL | BM 150 TD | BM 200 TD | BM 250 TD | BM 330 TD | BM 400 TD | BM 500 TD | BM 600 TD | BM 700 TD | BM 1100 TD |
|------------------------------|-----------|-----------|-----------|-----------|-----------|-----------|-----------|-----------|------------|
| Class | 1 | 1 | 2 | 2 | 2 | 3 | 3 | 3 | 4 |
| Capacity [lt] | 150 | 200 | 250 | 330 | 400 | 500 | 600 | 700 | 1100 |
| Transmission | chain | chain | chain | chain | chain | chain | chain | chain | chain |
| Empty weight [kg] | 310 | 335 | 435 | 455 | 480 | 720 | 740 | 790 | 1060 |
| Full load weight [kg] | 670 | 815 | 1035 | 1247 | 1440 | 1920 | 2180 | 2470 | 3700 |
| Min/max flow rate [lt/min] | 30/60 | 30/60 | 40/75 | 35/75 | 35/75 | 70/150 | 70/150 | 70/150 | 100/115 |
| Max pression cont/peak [bar] | 175/225 | 175/225 | 175/225 | 210/300 | 210/300 | 150/310 | 150/310 | 150/310 | 205/330 |



GROUND SWEEPING

- Collecting bucket
- Polypropylene brush
- Attachment to the machine
- Extremely tough and rugged



SWEeper BUCKET HD



- Direct drive motor
- Brushes made of PPN Ø550 mm
- HB400 steel reversible screwed cutting edge and bottom reinforcements
- Works in forward and reverse gear

SWEeper BUCKET D



- Brushes made of PPN Ø590mm
- N. 2 Ø250x50mm support wheels
- Mechanical working angle adjustment
- Hydraulic opening and closing of the collection bucket
- Works in forward gear
- Hooks for: forklift truck, tractor, earth moving machines
- Suitable for skid loaders, forklift trucks, telehandlers, compact wheel loaders



SWEeper BUCKET DS



Ø660 mm polypropylene brush

N. 3 Ø250x60mm support wheels

Internal hydraulic drive

Mechanical working angle adjustment

Hydraulic opening and closing of the collection bucket

Works in forward gear

Hooks for: forklift truck, tractor, earth moving machines

Suitable for telehandlers, backhoe loaders, wheel loaders from 90 hp to 170 hp

SWEeper BUCKET C



Ø750 mm polypropylene brush

N. 3 Ø405x110mm support wheels

Internal hydraulic drive

Mechanical working angle adjustment

Hydraulic opening and closing of the collection bucket

Works in forward gear

Hooks for: forklift truck, tractor, earth moving machines

Suitable for wheel loaders from 180 hp.



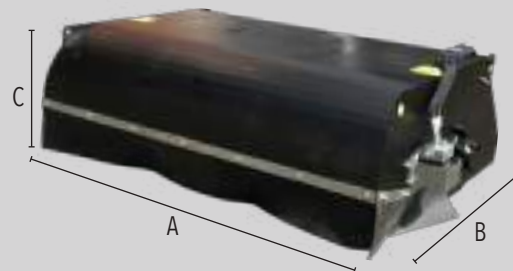

DIMENSIONS

| | | BS 140 HD | BS 155 HD | BS 180 HD | BS 210 HD | BS 240 HD |
|---|---------------|-----------|-----------|-----------|-----------|-----------|
| A | Width | 1670 | 1770 | 2070 | 2270 | 2610 |
| B | Depth | 1450 | 1450 | 1450 | 1450 | 1450 |
| C | Height | 620 | 620 | 620 | 620 | 640 |

The experience acquired over the years on the use of sweeper buckets has allowed us to improve some critical issues highlighted by customers. The steel reinforcements wear-resistant in the most stressed points of the collection bucket, the bolted and reversible HB400 blade makes the use of the HD sweeper buckets suitable for both construction sites burdensome than in normal road maintenance. The direct drive motor reduces maintenance and significantly reduces the time required for roller replacement.

OPTIONALS

| | | |
|--|--|--|
| | Nebulizers kit (without tank) | Brush shaft with mixed STEEL/PPN rings |
| Side brush r/l Ø 600 mm in polypropylene | Sprinkler kit 100 lt / 200 lt (only BS 240 HD) with electric pump and hose with nebulizers | Falling gravity sprinkler kit with 100 lt tank |
| Connector 8/14 poles | | |



| MODEL | BS 140 HD | BS 155 HD | BS 180 HD | BS 210 HD | BS 240 HD |
|----------------------------|-----------|-----------|----------------|-----------|-----------|
| Working width [mm] | 1400 | 1600 | 1800 | 2100 | 2400 |
| Weight [kg]* | 280 | 400 | 440 | 470 | 780 |
| Min/max flow rate [lt/min] | 50/90 | 50/90 | 50/90 | 50/90 | 75/90 |
| Min/max pressure [bar] | 230/295 | 230/295 | 230/295 | 230/295 | 230/300 |
| Ø Brush [mm] | 550 | 550 | 550 | 550 | 600 |
| Number of rollers [n°] | 2x700 | 2x750 | 1x800 - 1x1000 | 2x1000 | 3x750 |
| Bucket capacity [lt] | 385 | 450 | 510 | 560 | 620 |

* The value stated in the table refers to the mass of the sweeper bucket with universal attachment for skid loader



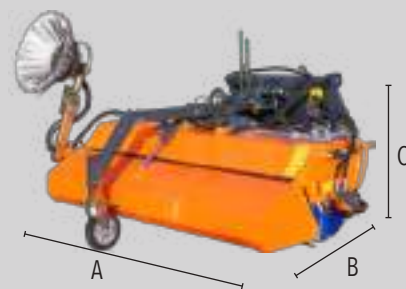

DIMENSIONS

| | | BS 135 D | BS 150 D | BS 180 D | BS 200 D | BS 230 D | BS 260 D |
|---|---------------|----------|----------|----------|----------|----------|----------|
| A | Width | 1680 | 1830 | 2130 | 2330 | 2630 | 2930 |
| B | Depth | 1650 | 1650 | 1650 | 1650 | 1650 | 1650 |
| C | Height | 1200 | 1200 | 1200 | 1200 | 1200 | 1200 |

The Sweeper bucket M3 series D is designed for customers who work both in the field of cable or phone laying sectors as well as road maintenance.

It can be fitted to any kind of skid steer loader and is equipped with hydraulically operated collecting bucket - PPN brush Ø 590 mm., no. 2 support wheels 250x50 mm, hydraulic hoses, integrated motor, self-leveling attachment (optional) and mechanical working angle adjustment.

OPTIONALS

| | | |
|---|--|--|
| | Overflow valve | 3rd front wheel Ø 250x50 mm |
| Ø600 mm PPN side brush right/left | Internal hydraulic motor | Hydraulic working angling adjustment (an additional hydraulic line is required) |
| 100 lt water tank with electric pump and nebulizers | 200 lt water tank with electric pump and nebulizers (not available in mod. BS135D) | Solenoid valve kit to operate the hydraulic adjustment (if the machine is not equipped with 2 hydraulic lines) |





| MODEL | BS 135 D | BS 150 D | BS 180 D | BS 200 D | BS 230 D | BS 260 D |
|--|----------|----------|----------|----------|----------|----------|
| Working width [mm] | 1350 | 1500 | 1800 | 2000 | 2300 | 2600 |
| Working width with 20° angle [mm] | 1270 | 1410 | 1690 | 1880 | 2160 | 2440 |
| Required oil flow (for 160bar) [l/min] | 30 | 30 | 30 | 40 | 40 | 50 |
| Ø Brush [mm] | 590 | 590 | 590 | 590 | 590 | 590 |
| Weight with collecting bucket [kg] | 329 | 344 | 373 | 398 | 429 | 462 |
| Capacity of collecting bucket [kg] | 166 | 184 | 220 | 244 | 280 | 315 |



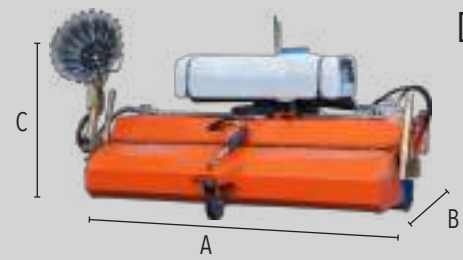

DIMENSIONS

| | | BS 200 DS | BS 230 DS | BS 260 DS | BS 280 DS |
|---|---------------|-----------|-----------|-----------|-----------|
| A | Width | 2230 | 2530 | 2830 | 2990 |
| B | Depth | 1850 | 1850 | 1850 | 1850 |
| C | Height | 1200 | 1200 | 1200 | 1200 |

The Sweeper bucket M3 series DS is designed for customers who work both in the field of cable or phone laying sectors as well as road maintenance.

It can be fitted to any kind of wheel-loader, back-hoe-loader, telescopic and is equipped with collecting bucket hydraulic operated - PPN brush Ø 660 mm., no. 3 support wheels 250x60 mm, hydraulic hoses, integrated motor, self-leveling attachment (optional) and mechanical working angle adjustment.

OPTIONALS

| | | |
|--|--|---|
| | Overflow valve | Side brush right or left Ø 600 mm in PPN and STEEL |
| Solenoid valve kit to operate the hydraulic adjustment (if the machine is not equipped with 2 hydraulic lines) | Water tank 200 l with electric pump and nebulizers | Hydraulic working angling adjustment (an additional hydraulic line is required) |
| Nebulizer kit (without tank) | | |





| MODEL | BS 200 DS | BS 230 DS | BS 260 DS | BS 280 DS |
|--|-----------|-----------|-----------|-----------|
| Working width [mm] | 2000 | 2300 | 2600 | 2800 |
| Working width with 20° angle [mm] | 1880 | 2160 | 2440 | 2600 |
| Required oil flow (for 160bar) [l/min] | 40 | 40 | 50 | 50 |
| Ø Brush [mm] | 660 | 660 | 660 | 660 |
| Weight with collecting bucket [kg] | 575 | 610 | 644 | 661 |
| Capacity of collecting bucket [kg] | 315 | 361 | 407 | 431 |





DIMENSIONS

| | | BS 210 C | BS 240 C | BS 280 C |
|---|---------------|----------|----------|----------|
| A | Width | 2360 | 2660 | 2990 |
| B | Depth | 2230 | 2230 | 2230 |
| C | Height | 1200 | 1200 | 1200 |

The Sweeper Bucket M3 series C is suitable for the cleaning of pavings and courtyard areas of industrial plants.

It can be fitted to any type of wheelloaders, backhoe loaders and telehandlers and is equipped with collecting bucket hydraulic operated, PPN brush Ø 750 mm, hydraulic hoses, no. 3 support wheels 405x110 mm, integrated motor, self-leveling attachment (optional) and mechanical working angle adjustment.

OPTIONALS

| | | |
|--|--|---|
| | Overflow valve | Extra strong wheels Ø 410x145 mm |
| Side brush right or left Ø 750 mm in PPN and STEEL | Solenoid valve kit to operate the hydraulic adjustment (if the machine is not equipped with 2 hydraulic lines) | Hydraulic working angling adjustment (an additional hydraulic line is required) |
| Water tank 200 l with electric pump and nebulizers | Water tank 400 l with electric pump and nebulizers | Nebulizer kit (without tank) |



| MODEL | BS 210 C | BS 240 C | BS 280 C |
|--|----------|----------|----------|
| Working width [mm] | 2100 | 2400 | 2800 |
| Working width with 20° angle [mm] | 1950 | 2250 | 2550 |
| Required oil flow (for 160bar) [l/min] | 56 | 56 | 56 |
| Ø Brush [mm] | 750 | 750 | 750 |
| Weight with collecting bucket [kg] | 795 | 904 | 957 |
| Capacity of collecting bucket [kg] | 450 | 480 | 550 |



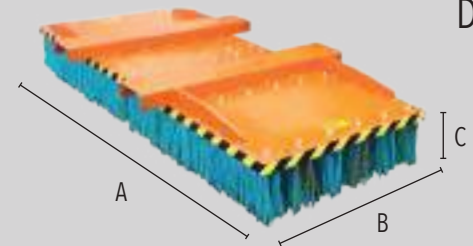

DIMENSIONS

| | SI 150I | SI 151I | SI 150IP | SI 151IP | SI 200I | SI 201I | SI 200IP | SI 201IP | SI 250I | SI 251I | SI 250IP | SI 251IP | SI 300I | SI 300IP | SI 201IR | SI 251IR |
|-----------------|---------|---------|----------|----------|---------|---------|----------|----------|---------|---------|----------|----------|---------|----------|----------|----------|
| A Width | 1400 | 1400 | 1400 | 1400 | 1900 | 1900 | 1900 | 1900 | 2400 | 2400 | 2400 | 2400 | 2900 | 2900 | 1900 | 2400 |
| B Depth | 500 | 700 | 500 | 700 | 700 | 1000 | 700 | 1000 | 700 | 1000 | 700 | 1000 | 1000 | 1000 | 1000 | 1000 |
| C Height | 400 | 400 | 400 | 400 | 400 | 400 | 400 | 400 | 400 | 400 | 400 | 400 | 400 | 400 | 400 | 400 |

- With interchangeable welded iron strips (I series) or interchangeable PPN strips (IP series)
- Attachments for lifting forks

The broom sweeper M3 is suitable for the cleaning of large yards, industrial areas, market and scrap collection. It can be fitted to any type of forklift or machine, wear-resistant and completely recyclable. It is equipped with interchangeable welded iron strips (series I) or interchangeable strips in PPN (series IP) and attachment for lifting forks.

OPTIONALS

| | | |
|--------------------|------------------------|-------------------------|
| | Spare kit - PPN strips | Spare kit - IRON strips |
| Frontal push blade | Containment sides | |





| MODEL | SI 150 I | SI 151 I | SI 150 IP | SI 151 IP | SI 200 I | SI 201 I | SI 200 IP | SI 201 IP | SI 250 I | SI 251 I | SI 250 IP | SI 251 IP | SI 300 I | SI 300 IP | SI 201 IR | SI 251 IR |
|--------------|----------|----------|-----------|-----------|----------|----------|-----------|-----------|----------|----------|-----------|-----------|----------|-----------|-----------|-----------|
| Sectors [n°] | 12 | 15 | 12 | 15 | 20 | 24 | 20 | 24 | 25 | 30 | 25 | 30 | 36 | 36 | 24 | 30 |
| Weight [kg] | 230 | 250 | 200 | 220 | 250 | 270 | 230 | 250 | 340 | 360 | 300 | 330 | 430 | 400 | 450 | 575 |



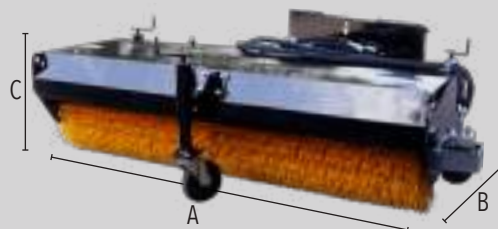

DIMENSIONS

| | | SA 150 | SA 180 | SA 210 | SA 240 |
|---|---------------|--------|--------|--------|--------|
| A | Width | 1770 | 2070 | 2270 | 2670 |
| B | Depth | 1620 | 1620 | 1620 | 1620 |
| C | Height | 650 | 650 | 650 | 650 |

- Attachments for skid steer loaders
- Direct drive hydraulic motor

The angled Broom Sweeper M3 fits any kind of skid steer loaders, loaders and telehandlers. Thanks to its strong structure can be used for the cleaning of building sites, streets, large courtyard areas or as a snow blade, in case of light snowfalls.

It is equipped with the integrated direct drive hydraulic motor, hydraulic hoses complete with quick couplings (only on SSL), attachment system with mechanical angle +/-30°, PPN brush Ø 550 mm, n. 2 support wheels Ø 200x50 mm and attachment to fit skid steer loader.

OPTIONALS

| | | |
|---|------------------------------------|--|
| | Floating Attachment with 3rd wheel | Hydraulic Angling complete with valve and cylinder |
| Sprinkler kit with 100 Lt Tank, electric pump and hoses with nebulizers | 3rd wheel Ø 200x50 mm | |



| MODEL | SA 150 | SA 180 | SA 210 | SA 240 |
|-----------------------------------|---------|----------------|---------|---------|
| Working width [mm] | 1500 | 1800 | 2100 | 2400 |
| Working width with 30° angle [mm] | 1299 | 1566 | 1736 | 2078 |
| Min/max flow rate [lt/min] | 25/100 | 25/100 | 25/100 | 25/100 |
| Min/max pressure [bar] | 100/250 | 100/250 | 100/250 | 100/250 |
| Ø Brush [mm] | 550 | 550 | 550 | 550 |
| Number of rollers [n°] | 2x750 | 1x800 - 1x1000 | 2x1000 | 3x800 |
| Weight [kg] * | 295 | 310 | 380 | 416 |

(*) The value stated in the table refers to the mass of the angled broom sweeper with universal attachment for skid loader.



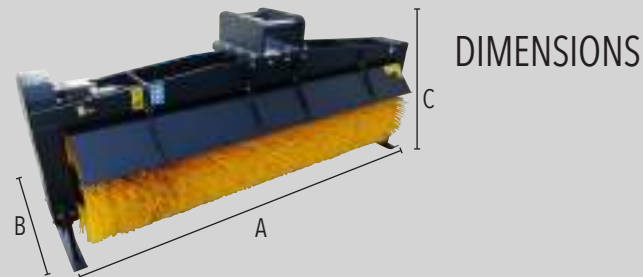

| | | SPE 150 | SPE 180 | SPE 210 |
|---|---------------|---------|---------|---------|
| A | Width | 1760 | 2060 | 2360 |
| B | Depth | 600 | 600 | 600 |
| C | Height | 816 | 816 | 816 |

- Hydraulic motor with chain transmission
- Drilled plate to be bolted to any excavator bolt-in plate

The excavator sweeper M3 is the best solution to clean trenches, road edges and place difficult to be reached.

The sweeper is supplied with hydraulic drive motor, chaine transmission, hydraulic hoses L. 2000 mm (without quick couplings) PPN brush Ø 600 mm and drilled plate to be bolted to any excavator.

OPTIONALS

Welded hooks to fit excavator

Bolt-in plate for excavator





| MODEL | SPE 150 | SPE 180 | SPE 210 |
|-----------------------------|---------|---------|---------|
| Working width [mm] | 1500 | 1800 | 2100 |
| Max pressure [cont - l/min] | 180 | 180 | 180 |
| Oil flow [cont - l/min] | 60 | 60 | 60 |
| Hydraulic motor [cc] | 250 | 250 | 250 |
| Ø Brush [mm] | 600 | 600 | 600 |
| Number of rings [n°] | 25 | 30 | 35 |
| Transmission | chain | chain | chain |
| Weight [kg] | 205 | 230 | 250 |





The Quick-Hitch M3 without modification of the original bucket can be attached to almost any kind of equipment and completely eliminates the usual long changeover times. It can be fitted to any back-hoe loader and avoids any intervention in the workshop and significantly increases the productivity of the machine.

The Quick-Hitch M3 with modification of the original bucket does neither change the center of gravity of the machine nor alter the load capacity and the breakout force. It is particularly appreciated in tough working conditions, where maximum performance is required by the machine.





DIMENSIONS

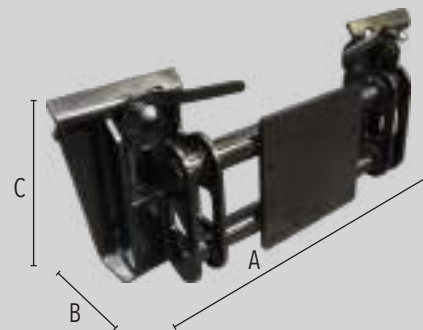

| | | |
|---|---------------|------|
| A | Width | 1130 |
| B | Depth | 500 |
| C | Height | 200 |

- It is supplied with a blank plate to which the specific coupling, depending on the machine, can be attached.

The new adaptor plate M3 can be attached to any equipment with skid steer loader attachment even on other operating machines.

In a quick and easy way, any equipment can be moved from the skid loader to the excavator rather than to the telescopic or to a backhoe. The best solution for a fast exchange making your job easier. It is equipped with welded attachment for loaders / backhoe / telescopic loaders or with bolted counterplate on which the excavator hooks can be welded.



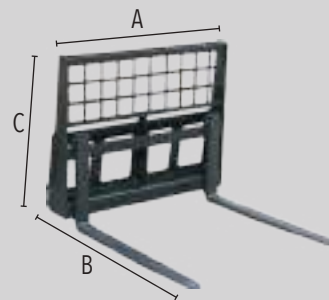

DIMENSIONS

| | | PPF S10-10 | PPF S10-12 | PPF S18-10 | PPF S18-12 | PPF S20-12 | PPF 18-12 | PPF 20-12 | PPF 25-12 | PPF 35-12 | PPF 45-12 | PPF 60-12 | PPF 80-12 | PPF 120-12 |
|---|---------------|------------|------------|------------|------------|------------|-----------|-----------|-----------|-----------|-----------|-----------|-----------|------------|
| A | Width | 1200 | 1200 | 1200 | 1200 | 1500 | 1500 | 1500 | 1500 | 1500 | 1500 | 1500 | 1500 | 1500 |
| B | Depth | 1000 | 1200 | 1000 | 1200 | 1200 | 1200 | 1200 | 1200 | 1200 | 1200 | 1200 | 1200 | 1200 |
| C | Height | 920 | 920 | 920 | 920 | 970 | 415 | 415 | 415 | 515 | 515 | 645 | 645 | 645 |

- The version for skid steer loader is equipped with grilled rollover protection

skid steer loader is equipped with grilled rollover protection.

The Fork Carriage M3 can be attached to any type of skid steer loader, back-hoe loader or wheel loader. They are available in various lifting capacities ranging from 1000 kg. up to 12.000 kg. with both forks, on request available also with lifting capacity up to 30.000 kg. The version for



| MODEL | PPF S10-10 | PPF S10-12 | PPF S18-10 | PPF S18-12 | PPF S20-12 | PPF 18-12 | PPF 20-12 | PPF 25-12 | PPF 35-12 | PPF 45-12 | PPF 60-12 | PPF 80-12 | PPF 120-12 |
|-----------------------|------------|------------|-------------|-------------|-------------|-------------|-------------|-------------|-------------|-------------|-------------|-------------|-------------|
| Working width [mm] | 1200 | 1200 | 1200 | 1200 | 1500 | 1500 | 1500 | 1500 | 1500 | 1500 | 1500 | 1500 | 1500 |
| Forks dimensions [mm] | 80x30x1000 | 80x30x1200 | 100x35x1000 | 100x35x1200 | 120x35x1200 | 100x35x1200 | 120x35x1200 | 120x40x1200 | 120x45x1200 | 120x50x1200 | 150x60x1200 | 200x60x1200 | 200x70x1200 |
| Load capacity [kg] | 1000 | 1000 | 1800 | 1800 | 2000 | 1800 | 2000 | 2500 | 3500 | 4500 | 6000 | 8000 | 12000 |



SIDESHIFT

GROUND LEVELLING

- Extremely tough and rugged
- Heavy cylinders
- Pneumatic floating wheels for high adaptability to the ground
- Attachment to the machine



GRADER BLADE



- On/off distributor
- ST52 steel structure
- Manual flow regulator
- Electrical control kit



DUAL GRADER BLADE



- Proportional and on/off distributor
- It works both as a grader blade and as a tilt dozer blade
- Double bevel curved bolted blade
- Over center valve on wheel lifting cylinder



Control joystick





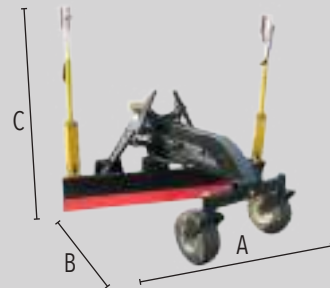

DIMENSIONS

| | | GR 230 | GR 250 | GR 270 |
|---|---------------|--------|--------|--------|
| A | Width | 2300 | 2500 | 2700 |
| B | Depth | 2360 | 2360 | 2360 |
| C | Height | 1480 | 1480 | 1480 |

The Grader Blade M3 can be fitted to the small skid steer loaders with power ranging from 50 to 120 HP is ideal for the preparation and the leveling of lands, roads and yards. It is equipped with the tilt system 32°, oscillation 40° and translation 450 mm of the blade through an hydraulically controlled push button, manual flow regulator on the distributor on / off, ST52 steel structure, attachment to the machine, hydraulic hoses and electric control kit.

OPTIONALS

| | Laser Control System (1) | Proportional distributor (2) | | |
|-----------------------------------|--|---|--|--|
| Left/right side closing plate (3) |  |  |  |  |



| MODEL | GR 230 | GR 250 | GR 270 |
|----------------------------------|--------|--------|--------|
| Blade width [mm] | 2300 | 2500 | 2700 |
| Weight [kg] | 670 | 690 | 710 |
| Hydraulic blade inclination r/l | ±38° | ±38° | ±38° |
| Hydraulic blade oscillation r/l | ±32° | ±32° | ±32° |
| Hydraulic blade translation [mm] | ±450 | ±450 | ±450 |



1

3

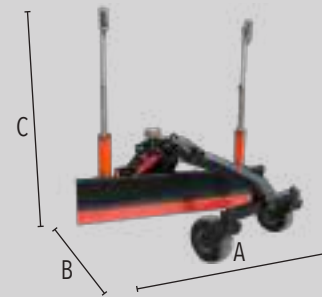

DIMENSIONS

GR 220/270

| | | |
|---|---------------|-----------|
| A | Width | 2200/2700 |
| B | Depth | 2500 |
| C | Height | 1900 |

The Grader Blade M3 Model Dual can be fitted to the small skid steer loaders with power ranging from 50 to 120 HP is ideal for the preparation and the leveling of lands, roads and yards.

It is equipped with an hydraulically controlled system by push button allowing the inclination at 26°, the oscillation at 15°, the blade height regulation ± 150mm, the lifting of the front wheels, a manual distributor on / off, blade extensions, attachment to the machine, hydraulic hoses and electric control kit.

OPTIONALS

| | | |
|----------------------|---|-----------------------------------|
| | Laser Control System (transmitter excluded) (1) | Left/right side closing plate (2) |
| Wi-fi control system | | |

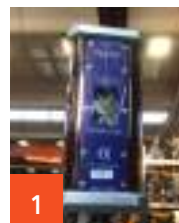



| | |
|--|-------------------|
| MODEL | GR 220/270 |
| Blade width [mm] | 2200/2700 |
| Weight [kg] | 850 |
| Hydraulic blade inclination r/l | $\pm 26^\circ$ |
| Hydraulic blade oscillation r/l | $\pm 15^\circ$ |
| Blade height [mm] | 540 |



GROUND MOVING

- Extremely tough and rugged
- Angle up to 30 degrees
- Heavy cylinders
- Replaceable bolt-on edge
- Skid loader attachments



DOZER BLADE

* compact wheel loaders up to 80hp



Hydraulic hoses with quick couplings

Shockproof valve



DOZER TILT BLADE

* compact wheel loaders up to 80hp



LEVELING BOX DOZER BLADE



Hydraulic hoses with quick couplings

Shockproof valve

1/2" valve

Hydraulic oscillation +/- 8°

Standard electric kit

Proportional distributor

Rear pad with hydraulic control which neutralizes the riding effect

Laser control system

Bolt-in blade

Electrically controlled kit

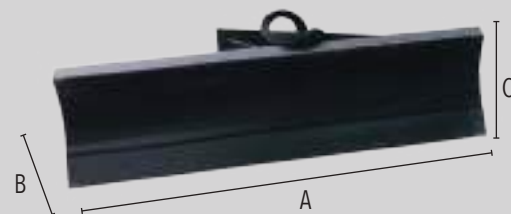

DIMENSIONS

| | | DB 150 | DB 180 | DB 210 | DB 240 | DB 270 |
|---|---------------|--------|--------|--------|--------|--------|
| A | Width | 1510 | 1810 | 2110 | 2410 | 2710 |
| B | Depth | 600 | 600 | 600 | 600 | 600 |
| C | Height | 730 | 730 | 730 | 730 | 730 |

- It is equipped with shockproof valve
- HB400 wear&tear steel bolted blade

The M3 dozer blade can be easily fitted to any kind of skid steer loader.

It is equipped with shockproof valve, hydraulic angling $\pm 30^\circ$, electric valve with hydraulic hoses, HB400 wear&tear steel bolted blade and universal attachment to fit the machine.



* compact wheel loaders up to 80hp



| MODEL | DB 150 | DB 180 | DB 210 | DB 240 | DB 270 |
|---------------------------------|--------|--------|--------|--------|--------|
| Working width [mm] | 1299 | 1560 | 1820 | 2075 | 2330 |
| Weight [kg] | 340 | 370 | 400 | 420 | 450 |
| Hydraulic blade inclination r/l | ±30° | ±30° | ±30° | ±30° | ±30° |



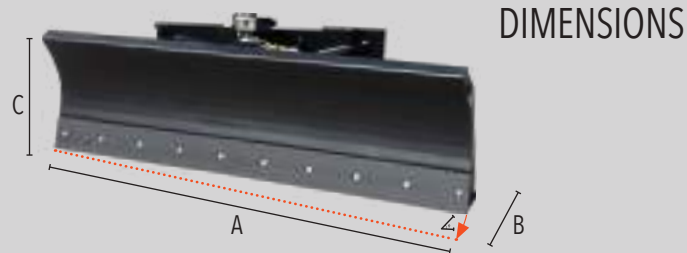

DIMENSIONS

| | | TDB 180 | TDB 210 | TDB 240 | TDB 270 |
|---|---------------|---------|---------|---------|---------|
| A | Width | 1810 | 2110 | 2410 | 2710 |
| B | Depth | 600 | 600 | 600 | 600 |
| C | Height | 730 | 730 | 730 | 730 |

- It is equipped with shockproof valve
- HB400 wear&tear steel bolted blade
- Electric valve complete with hydraulic hoses

The M3 tilt dozer blade can be easily fitted to any kind of skid steer loader.

It is equipped with shockproof valve, hydraulic angling $\pm 30^\circ$, hydraulic oscillation $\pm 8^\circ$, electric valve with hydraulic hoses, HB400 wear&tear steel bolted blade and attachment to fit skid loader.



| MODEL | TDB 180 | TDB 210 | TDB 240 | TDB 270 |
|---------------------------------|---------|---------|---------|---------|
| Working width [mm] | 1560 | 1820 | 2075 | 2330 |
| Weight [kg] | 360 | 390 | 430 | 490 |
| Max pressure [bar] | 250 | 250 | 250 | 250 |
| Oil flow [l/min] | 100 | 100 | 100 | 100 |
| Hydraulic blade inclination r/l | ±30° | ±30° | ±30° | ±30° |
| Hydraulic blade oscillation r/l | ±8° | ±8° | ±8° | ±8° |



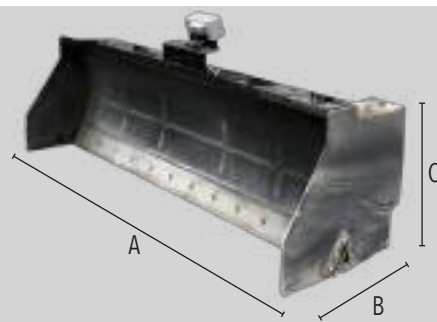

DIMENSIONS

LL 240

| | | |
|---|---------------|------|
| A | Width | 2430 |
| B | Depth | 830 |
| C | Height | 790 |

M3's self levelling blade suitable for backfilling works, drafting of landfill materials and indoor ground levelling with excellent finishing level.

With horizontal plane inclination system controlled by two hydraulic cylinders which allows the blade's up and down movement. Moreover equipped with an innovative rear skate managed by hydraulic cylinder with relief valve which keep fixed pressure on the skate to the ground to keep perfect levelling conditions even in case of ride controlled machines using and to neutralize riding effects.

Supplied with hydraulic proportional distributor, reliefs valve calibrate for having constant pressure, as option is available a wireless control system, levelling systems, receivers, wirings and receiver's poles. As option is available a wireless control system, levelling systems, receivers, wirings and receiver's poles.

OPTIONALS

| |
|----------------------|
| Wi-fi control system |
|----------------------|





| | |
|--------------------------------|---------------|
| MODEL | LL 240 |
| Blade width [mm] | 2400 |
| Weight [kg] | 950 |
| Total blade height [mm] | 740 |
| Depth [mm] | 830 |



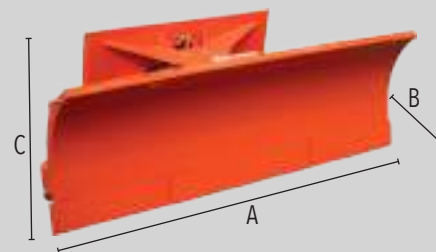

DIMENSIONS

| | | SB 150 | SB 180 | SB 210 | SB 240 | SB 270 |
|---|---------------|--------|--------|--------|--------|--------|
| A | Width | 1500 | 1800 | 2100 | 2400 | 2700 |
| B | Depth | 710 | 710 | 710 | 710 | 710 |
| C | Height | 730 | 730 | 730 | 730 | 730 |

- Shockproof system with spring return straight on the plow allowing a faster use
- Marker lights
- It is equipped with shockproof valve

The snow plow M3 can be easily fitted to all types of skid steer loaders and loaders up to 80 HP. It is supplied with shockproof valve, shockproof system with spring return straight on the plow allowing a faster use, marker lights, hydraulic angle $\pm 30^\circ$, oscillation $\pm 7^\circ$, hydraulic hoses and attachment to the machine.

OPTIONALS

| | | |
|--------------------|---------------------|-------------------------------|
| | Support bracket kit | Sectors blade in polyurethane |
| Support wheels kit | Top support | Floating attachment |



| MODEL | SB 150 | SB 180 | SB 210 | SB 240 | SB 270 |
|---------------------------------|--------|--------|--------|--------|--------|
| Working width [mm] | 1299 | 1560 | 1820 | 2075 | 2330 |
| Weight [kg] | 340 | 370 | 400 | 420 | 450 |
| Hydraulic blade inclination r/l | ±30° | ±30° | ±30° | ±30° | ±30° |
| Hydraulic blade oscillation r/l | ±7 | ±7 | ±7 | ±7 | ±7 |



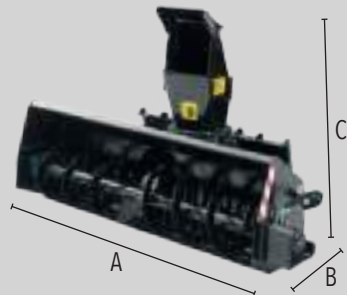

DIMENSIONS

| | | MFN 150 | MFN 180 | MFN 210 | MFN 245 |
|---|---------------|---------|---------|---------|---------|
| A | Width | 1750 | 2050 | 2350 | 2450 |
| B | Depth | 980 | 980 | 980 | 1300 |
| C | Height | 1250 | 1250 | 1250 | 1250 |

- Helix Ø 370 mm
- Rotation deflector: electrical

The snow blower M3 is the perfect equipment for snow. It is produced in different models to fit machines with different widths and can be attached to all types of skid steer loaders, backhoe loaders, compact wheel loaders. Thanks to its turbine that allows to blow the snow up to 15 mt, the snow blower can be used for cleaning walkways, driveways, sidewalks or in town centers where only a skid loader can effectively work. It is supplied with the rotation of deflector electrically or hydraulically operated, hélice and attachment to fit the machine.

OPTIONALS

Chute height mt 2,75



| MODEL | | | | |
|----------------------------|------------|------------|------------|------------|
| | MFN 150 | MFN 180 | MFN 210 | MFN 245 |
| Working width [mm] | 1500 | 1800 | 2100 | 2450 |
| Screw diameter [mm] | 370 | 370 | 370 | 370 |
| Working speed [km/h] | 0/2 | 0/2 | 0/2 | 0/2 |
| Rotating deflector | electrical | electrical | electrical | electrical |
| Rotating deflector angle | 240° | 240° | 240° | 240° |
| Max snow level [mm] | 600 | 600 | 600 | 600 |
| Oil flow req. min [lt/min] | 65 | 65 | 65 | 65 |
| Discharge distance [m] | 15 | 15 | 15 | 15 |
| Weight [kg] | 380 | 400 | 420 | 650 |





DIMENSIONS

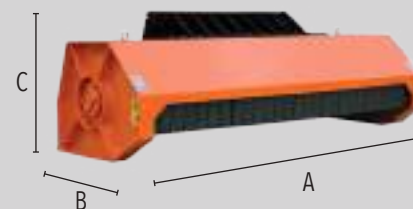

| | | MDC 10 | MDC 13 | MDC 16 | MDC 19 | MDM 13 | MDM 16 | MDM 19 |
|---|---------------|--------|--------|--------|--------|--------|--------|--------|
| A | Width | 1460 | 1500 | 1800 | 2200 | 1500 | 1800 | 2200 |
| B | Depth | 700 | 780 | 780 | 780 | 780 | 780 | 780 |
| C | Height | 450 | 570 | 570 | 570 | 570 | 570 | 570 |

- Maximum cutting diameter: 80 mm
- Direct drive hydraulic motor
- Rotor with knives
- Hammer rotor

The hydraulic bush cutter M3 is characterised by a strong structure and is specifically designed to be used on skid steer loaders.

It is manufactured in 4 models and equipped with a couple of "Y" knives and a third central knife to reduce any treated material to fine grains. It is supplied with hydraulic hoses and bolted plate to fit skid loader (excluding the model MDC10 supplied with a welded hook). The knives are of heavy type, suitable to crush shrubs with a maximum diameter of about 80 mm.

OPTIONALS

Hydraulic hoses kit



| MODEL | MDC 10 | MDC 13 | MDC 16 | MDC 19 | MDM 13 | MDM 16 | MDM 19 |
|----------------------------|-------------|--------------|-----------|-----------|--------------|-----------|-----------|
| Oil flow required [lt/min] | 26/36/44/55 | 55/66/80/100 | 66/80/100 | 66/80/100 | 55/66/80/100 | 66/80/100 | 66/80/100 |
| Drain | YES | NO | NO | NO | NO | NO | NO |
| Max pressure [bar] | 250 | 250 | 250 | 250 | 250 | 250 | 250 |
| Weight [kg] | 270 | 450 | 550 | 650 | 460 | 560 | 660 |
| Working width [mm] | 1080 | 1300 | 1600 | 1900 | 1300 | 1600 | 1900 |



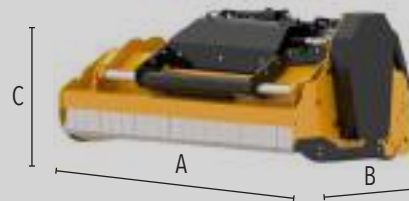

DIMENSIONS

| | | MHC5 160 | MHC5 180 | MHC5 200 | MHC10 160 HD | MHC10 180 HD |
|---|---------------|-------------|-------------|-------------|-----------------|-----------------|
| A | Width | 182 | 202 | 222 | 200 | 220 |
| B | Depth | 120 | 120 | 120 | 100 | 100 |
| C | Height | 110 | 110 | 110 | 160 | 160 |

- Maximum cutting diameter: 8 cm - 30 cm (HD series only)
- Hydraulic motor with belt transmission
- MKF knives rotor
- MHF hammers rotor

The M3 MHC series bushcutter featured by its solidity, is designed to fit skid loaders, compact and telescopic loaders up to 80/90 HP. Available in 2 versions, standard and HD. **The standard version** is equipped with universal oscillating and self-leveling attachment, mechanical side movement, valve block, sturdy and reinforced structure, helical rotor with tempered hammers (standard) or knives (optional), hydraulic motor with V-belt transmission. **The HD version** in addition is equipped with universal fixed attachment, rotor with fixed wide teeth, reinforced wear-resistant structure, pressure gauge for working pressure control, double rear chains for greater protection, piston motor and high performance HTD single belt transmission.

OPTIONALS

| | | |
|------------------------------------|--|---|
| | Hydraulic shift (not available in the HD series) | Hydraulic hoses kit |
| Hydraulic kit for front hood drive | Attachment for Backhoes / loaders / telehandlers | Mechanical push frame (only available in the HD series) |



| MODEL | MHC5 160 | MHC5 180 | MHC5 200 | MHC10 160 HD | MHC10 180 HD |
|-------------------------|-----------------|----------|----------|---------------|--------------|
| Working width [mm] | 1600 | 1800 | 2000 | 1600 | 1800 |
| Weight [kg] | 890 | 930 | 970 | 1285 | 1420 |
| Oil [lt/min] | 60/120 | 60/120 | 60/120 | 100/180 | 100/180 |
| Pression [bar] | 200/220 | 200/220 | 200/220 | 200/350 | 200/350 |
| Skid loader class [hp] | 50/90 | 50/90 | 50/90 | 70/120 | 70/120 |
| Rotor standard | MHF16 | MHF16 | MHF16 | MHF14 | MHF14 |
| Rotor optional | MKF3 | MKF3 | MKF3 | MHF15 | MHF15 |
| Motor displacement [cc] | 27/51 | 27/51 | 27/51 | 45/80 | 45/80 |
| Motor type | cast iron gears | | | pistons gears | |
| Knives number [n°] | 18 | 20 | 22 | 42 | 54 |



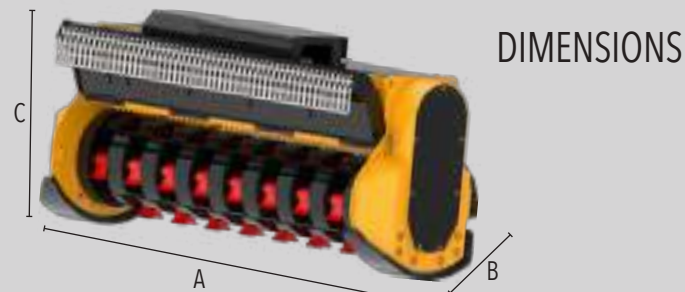

DIMENSIONS

| | | MH9 70HD2 | MH9 90HD2 | MH9 105HD2 | MH9 70HD3 | MH9 90HD3 | MH9 105HD3 | MH11 130HD2 | MH13 105HD2 | MH13 130HD2 | MH13 105HD3 | MH13 130HD3 | MH15 130HD2 | MH15 160HD2 | MH15 130HD3 | MH15 160HD3 | MH20 130HD3 | MH20 160HD3 | MH20 180HD3 |
|---|---------------|--------------|--------------|---------------|--------------|--------------|---------------|----------------|----------------|----------------|----------------|----------------|----------------|----------------|----------------|----------------|----------------|----------------|----------------|
| A | Width | 850 | 1050 | 1250 | 850 | 1050 | 150 | 1450 | 1250 | 1450 | 1250 | 1450 | 1600 | 1900 | 1600 | 1900 | 1700 | 2000 | 2000 |
| B | Depth | 800 | 800 | 800 | 800 | 800 | 800 | 900 | 950 | 950 | 950 | 950 | 800 | 800 | 800 | 800 | 1000 | 1000 | 1000 |
| C | Height | 600 | 600 | 600 | 600 | 600 | 600 | 600 | 850 | 850 | 850 | 850 | 850 | 850 | 850 | 850 | 900 | 900 | 900 |

The hydraulic mulching head M3 is designed with a strong and reliable structure and can easily fit almost any type of excavators. It is manufactured in different models, depending on the use and size of the excavator. It is supplied complete with hydraulic motor (piston motor from the MH15 series), valve block including anti-cavitation, priority, shockproof valve, adjustable support slides and perforated smooth plate.

OPTIONALS

| | | |
|------------------------|-----------------------|---------------------|
| | Self-leveling support | Hydraulic hoses kit |
| Knives and hammers kit | Mounting hitch | |





| MODEL | MH9 70HD2 | MH9 90HD2 | MH9 105HD2 | MH9 70HD3 | MH9 90HD3 | MH9 105HD3 | MH11 130HD2 | MH13 105HD2 | MH13 130HD2 | MH13 105HD3 | MH13 130HD3 | MH15 130HD2 | MH15 160HD2 | MH15 130HD3 | MH15 160HD3 | MH20 130HD3 | MH20 160HD3 | MH20 180HD3 |
|-------------------------|--------------|--------------|---------------|--------------|--------------|---------------|------------------|----------------|----------------|----------------|----------------|----------------|----------------|----------------|----------------|----------------|----------------|----------------|
| Working width [mm] | 700 | 900 | 1050 | 700 | 900 | 1050 | 1300 | 1050 | 1300 | 1050 | 1300 | 1300 | 1600 | 1300 | 1600 | 1300 | 1600 | 1800 |
| Weight [kg] | 220 | 330 | 400 | 340 | 400 | 460 | 440 | 580 | 650 | 685 | 745 | 920 | 1020 | 950 | 1050 | 1050 | 1185 | 1320 |
| Oil [lt/min] | 40/90 | 40/90 | 50/90 | 40/90 | 50/90 | 50/90 | 60/90 | 70/90 | 70/90 | 80/90 | 80/90 | 100/160 | 100/160 | 100/160 | 100/160 | 100/180 | 100/180 | 100/180 |
| Pression [bar] | 200/220 | 200/220 | 200/220 | 200/220 | 200/220 | 200/220 | 200/220 | 200/220 | 200/220 | 200/220 | 200/220 | 200/250 | 200/250 | 200/250 | 200/250 | 200/350 | 200/350 | 200/350 |
| Excavator class [t] | 5,0-8,0 | 6,0-8,0 | 6,0-12,0 | 5,0-12,0 | 6,0-12,0 | 6,0-12,0 | 8,0-12,0 | 10,0-16,0 | 10,0-16,0 | 10,0-16,0 | 10,0-16,0 | 12,0-25,0 | 15,0-25,0 | 12,0-25,0 | 16,0-25,0 | 16,0-30,0 | 18,0-30,0 | 20,0-30,0 |
| Rotor standard | MHF17 | MHF17 | MHF17 | MHF14 | MHF14 | MHF14 | MHF19 | MHF19 | MHF19 | MHF14 | MHF14 | MHF11 | MHF13 | MHF14 | MHF14 | MHF14 | MHF14 | MHF14 |
| Rotor optional | - | - | - | MHF15 | MHF15 | MHF15 | - | - | - | MHF15 | MHF15 | MHF10 | MHF12 | MHF15 | MHF15 | MHF15 | MHF15 | MHF15 |
| Motor displacement [cc] | 22/51 | 22/51 | 27/51 | 22/51 | 27/51 | 27/51 | 44/51 | 44/51 | 44/51 | 44/51 | 44/51 | 32/64 | 32/64 | 32/64 | 32/64 | 45/80 | 45/80 | 45/80 |
| Motor type | gears | | | | | | cast iron gears* | | | | | | pistons gears | | | | | |
| Knives number [n°] | 12 | 18 | 22 | 18 | 24 | 30 | 18 | 16 | 18 | 30 | 36 | 26 | 32 | 36 | 42 | 36 | 42 | 54 |

* on request, a piston engine is also available

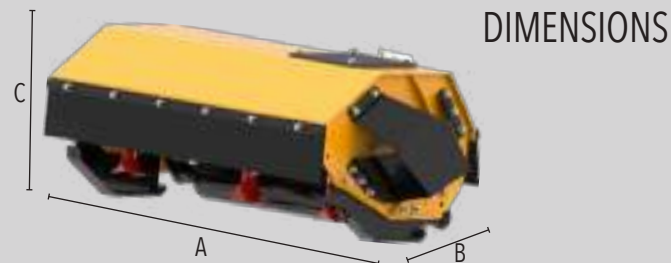

DIMENSIONS

| | | MH1 60 | MH1 80 | MH3 70 | MH3 90 | MH5 105 | MH7 105 | MH7 125 | MH9 70 | MH9 90 | MH9 105 | MH11 130 | MH11 160 | MH13 105 | MH13 130 |
|---|---------------|-----------|-----------|-----------|-----------|------------|------------|------------|-----------|-----------|------------|-------------|-------------|-------------|-------------|
| A | Width | 850 | 1000 | 950 | 1150 | 1300 | 1250 | 1450 | 850 | 1050 | 1250 | 1450 | 1850 | 1250 | 1450 |
| B | Depth | 500 | 500 | 550 | 550 | 600 | 750 | 750 | 800 | 800 | 800 | 900 | 1000 | 950 | 950 |
| C | Height | 350 | 350 | 450 | 450 | 400 | 500 | 500 | 600 | 600 | 600 | 600 | 700 | 850 | 850 |

The hydraulic mulching head M3 is designed with a strong and reliable structure and can easily fit almost any type of excavators. It is manufactured in different models, depending on the use and size of the excavator. It is supplied complete with hydraulic motor, leveling roller (MH3/5/7 models only) with adjustable height, direct transmission (up to MH7) belt transmission, valve block including anti-cavitation, priority, shockproof valve and perforated smooth plate.

OPTIONALS

| | | |
|--|-----------------------|---|
| | Self-leveling support | Hydraulic hoses kit |
| Knives and hammers kit | Mounting hitch | Front and rear chain protection (only for mod. MH1/3/5) |
| Support roller (only for mod. MH1 / 9/11/13) | | |





| MODEL | MH1 60 | MH1 80 | MH3 70 | MH3 90 | MH5 105 | MH7 105 | MH7 125 | MH9 70 | MH9 90 | MH9 105 | MH11 130 | MH11 160 | MH13 105 | MH13 130 |
|-------------------------|-----------|-----------|--------------|--------------|--------------|------------------|-----------|-----------|-----------|------------|------------------|-------------|------------|------------|
| Working width [mm] | 600 | 800 | 700 | 900 | 1050 | 1050 | 1250 | 700 | 900 | 1050 | 1300 | 1600 | 1050 | 1300 |
| Weight [kg] | 70 | 80 | 130 | 150 | 190 | 220 | 250 | 180 | 260 | 310 | 345 | 420 | 480 | 540 |
| Oil [lt/min] | 20/30 | 30/40 | 20/40 | 30/40 | 40/60 | 60/80 | 60/80 | 30 | 40/60 | 40/90 | 60/90 | 80/90 | 70/90 | 70/90 |
| Pression [bar] | 170/220 | 170/220 | 170/220 | 170/220 | 170/220 | 200/220 | 200/220 | 170/220 | 170/220 | 200/220 | 200/220 | 200/220 | 200/220 | 200/220 |
| Excavator class [t] | 1,2 - 3,0 | 1,2 - 3,0 | 1,5 - 5,0 | 2,0 - 5,0 | 4,0 - 6,0 | 6,0 - 8,0 | 6,0 - 8,0 | 3,0 - 4,0 | 4,0 - 8,0 | 6,0 - 10,0 | 6,0 - 12,0 | 10,0 - 12,0 | 8,0 - 16,0 | 8,0 - 16,0 |
| Rotor standard | MHF1 | MHF1 | MHF2 | MHF2 | MHF2 | MHF3 | MHF3 | MHF3 | MHF3 | MHF3 | MHF3 | MHF6 | MHF6 | MHF6 |
| Rotor optional | MKF1 | MKF1 | MHC1 MKC1 | MHC1 MKC1 | MHC1 MKC1 | MKF3 | MKF3 | MKF3 | MKF3 | MKF3 | MKF3 | MKF7 | MKF7 | MKF7 |
| Motor displacement [cc] | 8/11 | 8/11 | 8/16 | 11/16 | 16 | 22/34 | 22/34 | 16 | 22/34 | 22/51 | 34/51 | 44/51 | 44/51 | 44/51 |
| Motor type | gears | | | | | cast iron gears* | | gears | | | cast iron gears* | | | |
| Knives number [n°] | 12 | 16 | 12 | 16 | 16 | 16 | 20 | 10 | 14 | 16 | 20 | 20 | 16 | 20 |

* on request, a piston engine is also available



| |
|----------------------------|
| Knives MKF5 max cut Ø 6 cm |
| MODEL |
| MH 11/13/15 |



| |
|--|
| 360° rotating hammers MHF9 max cut Ø 12 cm |
| MODEL |
| MH 11/13HD2 |
| MHF9 *** |



| |
|--|
| 360° rotating hammers MHF11/13 max cut Ø 25 cm |
| MODEL |
| MH 15 HD2 |
| MHF11 *** |
| MHF13 *** |



| |
|-----------------------------|
| Hammers MHC1 max cut Ø 4 cm |
| MODEL |
| MH 3/5 |



| |
|-----------------------------|
| Hammers MHF3 max cut Ø 8 cm |
| MODEL |
| MH 7/9 |



| |
|-----------------------------|
| Hammers MHF6 max cut Ø 8 cm |
| MODEL |
| MH 11/13/15 |



| |
|-----------------------------------|
| Fixed teeth MHF14 max cut Ø 25 cm |
| MODEL |
| MH 13/15/20 HD3 |



| |
|-----------------------------|
| Hammers MHF1 max cut Ø 3 cm |
| MODEL |
| MH 1 |



| |
|----------------------------|
| Knives MKF1 max cut Ø 2 cm |
| MODEL |
| MH 1 |



| |
|-----------------------------|
| Hammers MHF2 max cut Ø 5 cm |
| MODEL |
| MH 3/5 |



| |
|--|
| 360° rotating hammers MHF7/8 max cut Ø 12 cm |
| MODEL |
| MH 9/11/13HD2 |
| MHF7 *** |
| MHF8 *** |



| |
|--|
| 360° rotating hammers MHF10/12 max cut Ø 25 cm |
| MODEL |
| MH 15 HD2 |
| MHF10 *** |
| MHF12 *** |



| |
|-----------------------------------|
| Fixed teeth MHF15 max cut Ø 20 cm |
| MODEL |
| MH 13/15/20 HD3 |



| |
|----------------------------|
| Knives MKC1 max cut Ø 3 cm |
| MODEL |
| MH 3/5 |



| |
|----------------------------|
| Knives MKF3 max cut Ø 6 cm |
| MODEL |
| MH 7/9 |





| MODEL | (Ton) | | | | | | | | | | | | | | | | |
|------------|-------|-----|-----|-----|-----|-----|-----|-----|------|------|------|------|------|------|------|------|--|
| | 1.0 | 2.0 | 3.0 | 4.0 | 5.0 | 6.0 | 7.0 | 8.0 | 10.0 | 12.0 | 14.0 | 16.0 | 18.0 | 20.0 | 25.0 | 30.0 | |
| MH1 | Ø3 | | | | | | | | | | | | | | | | |
| MH3 | Ø5 | | | | | | | | | | | | | | | | |
| MH5 | | | | Ø5 | | | | | | | | | | | | | |
| MH7 | | | | | Ø8 | | | | | | | | | | | | |
| MH9 | | | Ø8 | | | | | | | | | | | | | | |
| MH9 HD2 | | | | | Ø12 | | | | | | | | | | | | |
| MH9 HD3 | | | | | Ø25 | | | | | | | | | | | | |
| MH11 | | | | | | Ø8 | | | | | | | | | | | |
| MH11 HD2 | | | | | | | | Ø12 | | | | | | | | | |
| MH13 | | | | | | | | Ø8 | | | | | | | | | |
| MH13 HD2 | | | | | | | | | Ø12 | | | | | | | | |
| MH13 HD3 | | | | | | | | | Ø25 | | | | | | | | |
| MH15 | | | | | | | | | Ø8 | | | | | | | | |
| MH15 HD2/3 | | | | | | | | | | Ø25 | | | | | | | |
| MH20 HD3 | | | | | | | | | | | | Ø30 | | | | | |

The set-up of the auxiliary hydraulic system on the excavator is of exclusive pertinence and responsibility of the client. Should the client wish, instead, to operate the M3 mulcher by means of the existing hydraulic system in the excavator (ex. for operating demolition hammers, pincers, etc.), he must be aware that the performance of the mulcher may result decreased, in particular when the excavator's arm, the cabin and/ or the trucks/wheels are moving as well. Note also that a pressure on the return branch exceeding 15 bar would cause the leakage of the seal of the hydraulic motor with consequent loss of oil.



DIMENSIONS

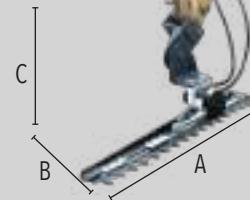

| | | MC 120 | MC 160 | MC 180 |
|---|---------------|--------|--------|--------|
| A | Width | 1265 | 1725 | 1875 |
| B | Depth | 220 | 220 | 220 |
| C | Height | 365 | 365 | 365 |

- Mechanical shock absorber
- Adjustable attachment system
- Blades protection
- Orbital motor protected by anti-shock and anti-cavitation valve

The M3 trimmer can be fitted to mini excavators and is suitable for cuttings of hedges (light pruning) up to a maximum Ø of 3 cm.

The blades are in wear resistant steel and it is equipped with adjustable attachment, orbital motor protected by anti-shock and anti-cavitation valve, mechanical shock absorber and blades protection.

OPTIONALS

Spare blades kit

Hydraulic hoses kit



| MODEL | MC 120 | MC 160 | MC 180 |
|------------------------|-----------|-----------|-----------|
| Weight [kg] | 42 | 55 | 64 |
| Max pressure [bar] | 180 | 180 | 180 |
| Max flow rate [lt/min] | 26/40/50 | 26/40/50 | 26/40/50 |
| Excavator class [t] | 1,0 - 5,0 | 2,0 - 6,0 | 2,0 - 6,0 |
| Cut width [mm] | 1200 | 1600 | 1800 |
| Max. Cut Ø [mm] | 30 | 30 | 30 |



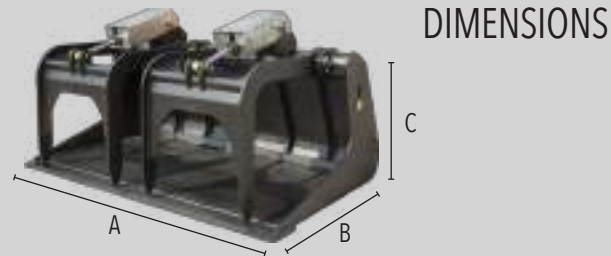

DIMENSIONS

| | | MPI 125 | MPI 140 | MPI 155 | MPI 170 | MPI 185 | MPI 200 |
|---|---------------|---------|---------|---------|---------|---------|---------|
| A | Width | 1250 | 1400 | 1550 | 1700 | 1850 | 2000 |
| B | Depth | 970 | 970 | 970 | 970 | 970 | 970 |
| C | Height | 800 | 800 | 800 | 800 | 800 | 800 |

- Low sides allow materials wider than bucket to be carried
- Heavy duty construction
- Twin cylinder with ram protection and stop valve

The industrial bucket with grapple M3 is ideal for the collection of waste, scrap and construction or industrial handling in paper mills.

It is equipped with no. 2 upper hydraulic clamps and attachment to the machine.



OPTIONALS

Side panels

| MODEL | MPI 125 | MPI 140 | MPI 155 | MPI 170 | MPI 185 | MPI 200 |
|--------------------|---------|---------|---------|---------|---------|---------|
| Weight [kg] | 280 | 300 | 320 | 340 | 360 | 380 |





DIMENSIONS

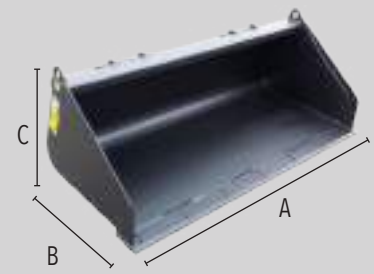

| | | BSK 110 | BSK 125 | BSK 140 | BSK 155 | BSK 170 | BSK 185 | BSK 200 |
|---|---------------|---------|---------|---------|---------|---------|---------|---------|
| A | Width | 1100 | 1250 | 1400 | 1550 | 1700 | 1850 | 2000 |
| B | Depth | 900 | 900 | 900 | 900 | 900 | 900 | 900 |
| C | Height | 600 | 600 | 600 | 600 | 600 | 600 | 600 |

- Steel drilled blade
- Steel bottom reinforcements

The Standard Bucket M3 shows a very strong structure and is easily attached to all types of skid steer loaders. It is equipped with steel drilled blade configured for the installation of teeth, steel bottom reinforcements and attachment to the machine.

OPTIONALS

| | | |
|--------------------------|------------------|--|
| Reversible screwed blade | Bolted teeth kit | |
|--------------------------|------------------|--|

| MODEL | BSK 110 | BSK 125 | BSK 140 | BSK 155 | BSK 170 | BSK 185 | BSK 200 |
|--------------------|---------|---------|---------|---------|---------|---------|---------|
| Capacity [lt] | 317 | 360 | 381 | 447 | 493 | 579 | 626 |
| Weight [kg] | 135 | 150 | 162 | 175 | 190 | 205 | 215 |
| Teeth number [no.] | 5 | 5 | 6 | 6 | 7 | 8 | 8 |



GROUND DRILLING

- Compact high torque gearbox
- Highly efficient design with less moving parts
- Fitted with customized Eaton geroler hydraulic motor
- No drain required
- Extreme duty shaft locking system
- Innovative design allows the gearbox to go down the hole to maximise drilling depth without extensions
- Low maintenance with 5yr gear box and 3yr motor warranty



AUGERS: MINI EXCAVATOR/SKID STEER LOADER STD





AUGERS: EXCAVATOR/SKID STEER LOADER STD/HF



AUGERS: EXCAVATOR





5YR GEAR BOX WARRANTY

3YR MOTOR WARRANTY

Compact high torque gearbox
 Highly efficient design with less moving parts
 Fitted with customized Eaton geroler hydraulic motor
 No drain required
 Extreme duty shaft locking system
 Innovative design allows the gearbox to go down the hole to maximise drilling depth without extensions
 Low maintenance with 5yr gear box and 3yr motor warranty



| EXCAVATOR HITCHES | |
|-------------------|---------|
| SINGLE PIN HITCH | |
| DIMENSIONS mm | |
| Ø 25 | 95/120 |
| Ø 30 | 95/120 |
| Ø 30 | 125/145 |
| Ø 35 | 125/145 |
| Ø 35 | 150/170 |

| SKID STEER FRAME |
|---------------------|
| DESCRIPTION |
| MPDD - MPDX2 - MPD3 |

| CRADLE HITCH | |
|---------------------|--------------------------|
| DESCRIPTION | HITCH BASE PLATE mm |
| MPDD - MPDX2 - MPD3 | 200x150x25 250x225x25 |

| EXTENSIONS |
|------------------|
| DIMENSIONS mm |
| Lenght 500 Ø 65 |
| Lenght 1000 Ø 65 |
| Lenght 1500 Ø 65 |

| DOUBLE PIN HITCH |
|-----------------------|
| HITCH BASE PLATE mm |
| 200x150x25 250x225x25 |

| AUGERS 65 Ø MM ROUND HUB | |
|--------------------------|------------------------------------|
| DIMENSIONS mm | MRC - MIXED TERRAIN AND ROCK Model |
| 150x1200 | MRC4-15 |
| 200x1200 | MRC4-20 |
| 250x1200 | MRC4-25 |
| 300x1200 | MRC4-30 |
| 400x1200 | MRC4-40 |
| 500x1200 | MRC4-50 |
| 600x1200 | MRC4-60 |



| MODEL | | MPDD | MPDX 2 | MPD 3 |
|--------------------------------|--------------|---------------------------|---------|---------|
| Horse power [kw] | | 25 | 25 | 25 |
| Max flow rate [lt/min] | | 15/45 | 30/50 | 45/75 |
| Min/max pressure [bar] | | 125/240 | 125/240 | 175/240 |
| Max torque [Nm] | | 1197 | 1320 | 3591 |
| Rotation speed [rpm] | | 49/148 | 41/83 | 41/83 |
| Motor type | | gearbox + hydraulic motor | | |
| Shaft [mm] | | Ø 65 | Ø 65 | Ø 65 |
| Weight [kg] | | 41 | 45 | 57 |
| Excavator class | | 0,75-2 | 1,5-2,5 | 2-5 |
| Tip for mixed terrain and rock | Tip kind | MRC4 | MRC4 | MRC4 |
| | Max diameter | 400 | 450 | 600 |

Included are no. 2 hydraulic hoses 1/2", L=2200 mm, quick couplings M/F F.P. 1/2"





5YR GEAR BOX WARRANTY

3YR MOTOR WARRANTY

Compact high torque gearbox
 Highly efficient design with less moving parts
 Fitted with customized Eaton geroler hydraulic motor
 No drain required
 Extreme duty shaft locking system
 Innovative design allows the gearbox to go down the hole to maximise drilling depth without extensions
 Low maintenance with 5yr gear box and 3yr motor warranty



| EXCAVATOR HITCHES | |
|-------------------|---------|
| SINGLE PIN HITCH | |
| DIMENSIONS mm | |
| Ø 40 | 150/170 |
| Ø 45 | 150/170 |
| Ø 45 | 175/200 |
| Ø 50 | 150/170 |
| Ø 50 | 175/200 |
| Ø 50 | 210/230 |

| SKID STEER FRAME | |
|-------------------|--|
| DESCRIPTION | |
| MPD5/7 | |
| MPD10 - MPD6/8 HF | |

| CRADLE HITCH | |
|--------------|---------------------|
| DESCRIPTION | HITCH BASE PLATE mm |
| MPD5/7/10 | 250x250x25 |
| 6HF/8HF | 275x250x25 |

| EXTENSIONS | |
|---------------|-----------|
| DIMENSIONS mm | |
| Lenght | 1000 Ø 75 |
| Lenght | 1500 Ø 75 |
| Lenght | 2000 Ø 75 |

| DOUBLE PIN HITCH | |
|---------------------|------------|
| HITCH BASE PLATE mm | |
| 250x250x25 | 275x250x25 |

| AUGERS 75 Ø MM SQUARE HUB | | | |
|---------------------------|---------|------------------------------|----------|
| DIMENSIONS mm | | MRC - MIXED TERRAIN AND ROCK | |
| | Model | | Model |
| 150x1500 | MRC6-15 | 600x1500 | MRC6-60 |
| 200x1500 | MRC6-20 | 750x1500 | MRC6-75 |
| 250x1500 | MRC6-25 | 900x1500 | MRC6-90 |
| 300x1500 | MRC6-30 | 1000x1500 | MRC6-100 |
| 400x1500 | MRC6-40 | 1200x1500 | MRC6-120 |
| 500x1500 | MRC6-50 | | |



| MODEL | | MPD 5 | MPD 7 | MPD 10 | MPD 6 HF | MPD 8 HF |
|--------------------------------|--------------|---------------------------|---------|---------|----------|----------|
| Horse power [kw] | | 25 | 25 | 25 | 60 | 60 |
| Max flow rate [lt/min] | | 60/95 | 75/115 | 85/115 | 60/150 | 80/200 |
| Min/max pressure [bar] | | 175/240 | 175/240 | 175/240 | 175/240 | 175/240 |
| Max torque [Nm] | | 5166 | 6048 | 8568 | 5670 | 7175 |
| Rotation speed [rpm] | | 41/70 | 43/73 | 38/52 | 41/102 | 43/107 |
| Motor type | | gearbox + hydraulic motor | | | | |
| Shaft [mm] | | Ø 75 | Ø 75 | Ø 75 | Ø 75 | Ø 75 |
| Weight [kg] | | 67 | 90 | 110 | 149 | 149 |
| Excavator class | | 4-8 | 5-10 | 5-10 | 5-10 | 5-10 |
| Tip for mixed terrain and rock | Tip kind | MRC6 | MRC6 | MRC6 | MRC6 | MRC6 |
| | Max diameter | 900 | 900 | 1000 | 1200 | 1200 |

Included are no. 2 hydraulic hoses 1/2", L=2200 mm, quick couplings M/F F.P. 1/2"





5YR GEAR BOX WARRANTY

3YR MOTOR WARRANTY

Compact high torque gearbox
 Highly efficient design with less moving parts
 Fitted with customized Eaton geroler hydraulic motor
 No drain required
 Extreme duty shaft locking system
 Innovative design allows the gearbox to go down the hole to maximise drilling depth without extensions
 Low maintenance with 5yr gear box and 3yr motor warranty



| EXCAVATOR HITCHES | |
|-------------------|--|
| SINGLE PIN HITCH | |
| DIMENSIONS mm | |
| Ø 65 mm | |
| Ø 70 mm | |
| Ø 75 mm | |

| EXTENSIONS | |
|---------------|------|
| DIMENSIONS mm | |
| Lenght 1000 | Ø 75 |
| Lenght 1500 | Ø 75 |
| Lenght 2000 | Ø 75 |
| Lenght 2500 | Ø 75 |

| CRADLE HITCH | |
|--------------|--------------------------|
| DESCRIPTION | HITCH BASE PLATE mm |
| MPD18/22 | 200x150x25 250x225x25 |

| DOUBLE PIN HITCH | |
|---------------------|--|
| HITCH BASE PLATE mm | |
| 325x300x25 | |

| AUGERS 75 Ø MM SQUARE HUB | | | |
|------------------------------|---------|-----------|----------|
| MRC - MIXED TERRAIN AND ROCK | | | |
| DIMENSIONS mm | Model | Model | Model |
| 200x1500 | MRC8-20 | 750x1500 | MRC8-75 |
| 250x1500 | MRC8-25 | 900x1500 | MRC8-90 |
| 300x1500 | MRC8-30 | 1000x1500 | MRC8-100 |
| 400x1500 | MRC8-40 | 1200x1500 | MRC8-120 |
| 500x1500 | MRC8-50 | 1500x1500 | MRC8-150 |
| 600x1500 | MRC8-60 | | |



| MODEL | | MPD 18 | MPD 22 |
|--------------------------------|--------------|---------------------------|---------|
| Horse power [kw] | | 60 | 60 |
| Max flow rate [lt/min] | | 130/230 | 140/230 |
| Min/max pressure [bar] | | 175/240 | 175/240 |
| Max torque [Nm] | | 17620 | 22257 |
| Rotation speed [rpm] | | 26/50 | 21/40 |
| Motor type | | gearbox + hydraulic motor | |
| Shaft [mm] | | Ø 75 | Ø 75 |
| Weight [kg] | | 176 | 176 |
| Excavator class | | 10-20 | 10-20 |
| Tip for mixed terrain and rock | Tip kind | MRC8 | MRC8 |
| | Max diameter | 1500 | 1500 |

Included are no. 2 hydraulic hoses 1/2", L=2200 mm, quick couplings M/F F.P. 1/2"



HOW TO ORDER A DRIVE UNIT

WHEN ORDERING A DRIVE UNIT, CHOOSE ONE ITEM FROM EACH CATEGORY

1 DRIVE UNITS

2,2 m hoses & couplers - linkage block and pin included (from MPDD to MPD3)
 3 m (from MPD5 to MPD22)

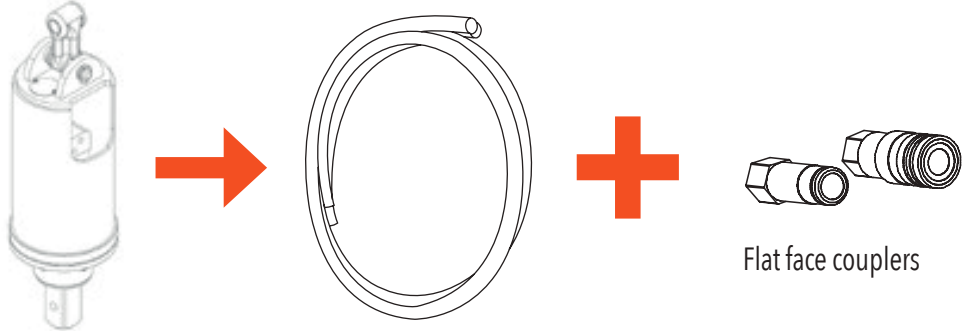

2 HITCH OR FRAME

Options available

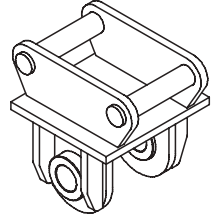

Single or double pin hitch

OR

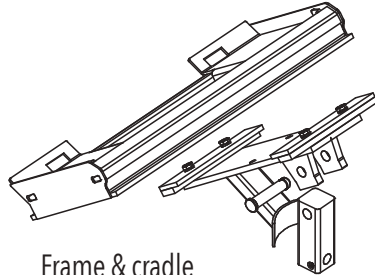

Frame & cradle

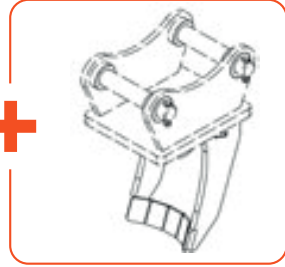

Cradle hitch
(recommended)

3 EXTENSIONS

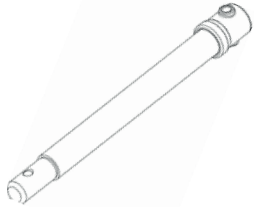

No.1 pin included

4 AUGERS

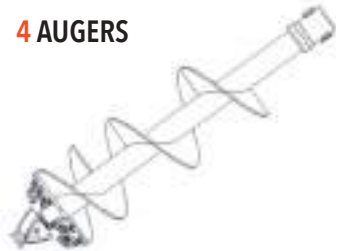

No.1 pin + kit for mixed terrain and rock

SPARE WEAR PART UNITS

(tool + pilots recommended)

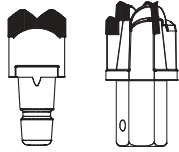

Spare wear part kits, available included outer teeth, inner teeth and nut&bolt



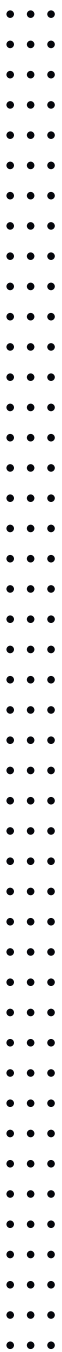

CATALOGUE

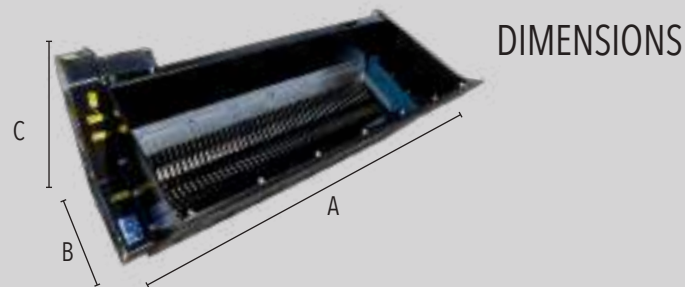

DIMENSIONS

| | | SF 120 | SF 150 | SF 180 | SF 210 |
|---|---------------|--------|--------|--------|--------|
| A | Width | 1365 | 1675 | 2007 | 2315 |
| B | Depth | 700 | 700 | 720 | 720 |
| C | Height | 780 | 780 | 980 | 980 |

- It is equipped with shockproof valve
- HB400 wear&tear steel screen
- Heavy duty construction with HB400

The front screening bucket M3 is designed to sort waste and demolition material, filling and reclamation of stony ground directly in the yard.

It can be fitted to all types of skid steer loaders and is equipped with hydraulic hoses and attachment to fit skid steer loader.





| MODEL | SF 120 | SF 150 | SF 180 | SF 210 |
|---------------------------------|--------|--------|--------|--------|
| Working width [mm] | 1200 | 1500 | 1800 | 2100 |
| Total width [mm] | 1500 | 1800 | 2100 | 2400 |
| Weight [kg] | 350 | 400 | 700 | 850 |
| Ø of the selected material [mm] | 20 | 20 | 20 | 20 |
| Oil flow rate [lt/min] | 40 | 40 | 60 | 60 |
| Max oil flow rate [lt/min] | 70 | 70 | 90 | 90 |
| Max pressure [bar] | 180 | 180 | 180 | 180 |



SALES CONDITIONS

ORDERS: They will be confirmed by M3 MetalMeccanicaModerna for regular acceptance. M3 MetalMeccanicaModerna will not accept any order involving penalties. The goods offered for prompt shipment or delivery shall always be intended with the clause "in terms of time and subject to sale expected." In the event of failure to collect the ordered goods, on our part, M3 MetalMeccanicaModerna can expect the execution of the contract or its resolution: in this latter case, the Purchaser shall pay 20% of the supplies as a penalty.

PRICES: They refer to the quoted ones at the date of acceptance. In case, in the course of supply any increase, for various reasons, may occur (materials, labor or otherwise), M3 MetalMeccanicaModerna shall have the option to adjust prices of the order, after written information.

TERMS OF DELIVERY: The delivery time indicated by M3 MetalMeccanicaModerna, while being observed as much as possible, has always to be considered as informational only. M3 MetalMeccanicaModerna assumes no responsibility for damages resulting from delays in delivery. M3 MetalMeccanicaModerna reserves the right to extend the forecast of delivery or to cancel the contract in the following cases: - Inaccuracies or delays by the Customer in submitting the data relevant for the proper execution of the order; - Force majeure absolutely unpredictable, such as strikes, natural disasters, delays by suppliers of the raw materials, etc.; - Default in payments by the customer.

SHIPPING: They are carried out on behalf of the Customer at his own peril. Complaints for possible tampering must be submitted by the Customer to the carrier. Claims for differences in quantities and / or exchanges in types, will be considered only if made in writing within 8 days from the receipt of the material.

PAYMENTS: Unless otherwise agreed, payments must be made at the domicile of the M3 MetalMeccanicaModerna as indicated in the invoices. After the expiration of the agreed deadline for payment, retaining the right to require payment, M3 MetalMeccanicaModerna will count on his credit interests of law. M3 MetalMeccanicaModerna may also suspend production of the ordered products or certainly cancel the residual ordering, giving notice to the Customer, without having to acknowledge payment or compensation of any kind, except any other right of M3 MetalMeccanicaModerna.

RETURNED ITEMS: Any item to be returned must be previously agreed with the M3 MetalMeccanicaModerna Sales Department and will be accepted only if the material and its packaging will be perfectly intact. In the case of special material, specifically produced, the return will absolutely not be accepted.

WARRANTY: M3 MetalMeccanicaModerna ensures that every new product is free from construction and material defects for a period of twelve (12) months from the date of delivery to the first owner/user. For this purpose, the date of delivery indicated on the invoice shall be considered authentic. To benefit from the warranty it is essential that: - the owner sends the "Warranty Certificate" to M3 MetalMeccanicaModerna within ten (10) days from receipt of the equipment. The "Warranty Certificate" must be completed in its entirety by the owner; - the defective

parts have to be sent to the Company M3 MetalMeccanicaModerna, for inspection, free of any charge and accompanied by the identification data indicated on the plate of the equipment. - the programs and timing of maintenance provided by the M3 MetalMeccanicaModerna are respected. M3 MetalMeccanicaModerna shall not recognize: - transportation costs, both for the new shipped parts and for those parts assumed to be defective, whose return to controls is asked for; - labor costs other than those of time schedules, costs for the installation and removal of equipment from the equipment M3; - costs of intervention out of workshop: travel, subsistence, miles, etc.; - costs for "downtime" and penalties for work not carried out due to failures of any kind and consequent loss of profit; - costs for replacement machines, commercial damages, etc. ; - damage caused by the use of the equipment M3 in a state of apparent or arising defect. The owner of the M3 equipment shall give a written notice to the relevant seller of the defect, when arising, and to accept the reasonably transport time necessary to transport, repair or replacement of defective parts. The warranty of the M3 equipment ends before the 12 months foreseen if: - changes have been made, tampering, alterations of any kind; - the routine maintenance has not been carried out or there has been a improper use; - the equipment is mounted on machines other than those envisaged at the time of delivery; - repairs or replacement of worn parts have been carried out with non original M3 spare parts; - the non-compliance with the terms of payment is found out. This guarantee does not cover parts subject to wear and tear (ie: bottom, mixing shafts, parts of rubbing, unloading trap) and the electrical components (f.i. coil, electrovalve, cable, switch). M3 MetalMeccanicaModerna excludes any other form of guarantee. No agent, dealer or representative is authorized to guarantee on behalf of M3 MetalMeccanicaModerna. The Customer, dealer or user, has to send to M3 MetalMeccanicaModerna the "FINAL TESTING SHEET" duly completed in all its parts.

TERMINATION OF CONTRACT: In case of change in the commercial conditions (declaration of incapacity, suspension of payments, request of concordat, subjugation to liens and mortgages, declaration of bankruptcy, name change, etc.) M3 MetalMeccanicaModerna has the right to demand guarantees or to terminate the contract without any right for the Customer.

RESPONSIBILITIES: M3 MetalMeccanicaModerna is not responsible regarding claims and direct or indirect damages to people or things that could occur during the use, caused by equipments, accessories or other materials of M3 MetalMeccanicaModerna supply, as specified in the operating manual.

VALIDITY: These "GENERAL TERMS AND CONDITIONS OF SALE" cancel and replace any other previous condition. Any exceptions to these terms will be valid only if specifically confirmed and accepted in writing by M3 MetalMeccanicaModerna.

JURISDICTION: Any disputes will be exclusively submitted to the Court of Parma.



M3 MetalMeccanica Moderna s.r.l.

Strada della Pace, 23 - Mezzani
43058 Sorbolo Mezzani (PR) - ITALY

Tel. +39 0521 316053 - **E-mail:** info@m3srl.com

www.m3srl.com

STUDIO24-7IT